

No. 3 ON C.V

Print ISSN : 2395-1990

Online ISSN : 2394-4099

www.ijsrset.com

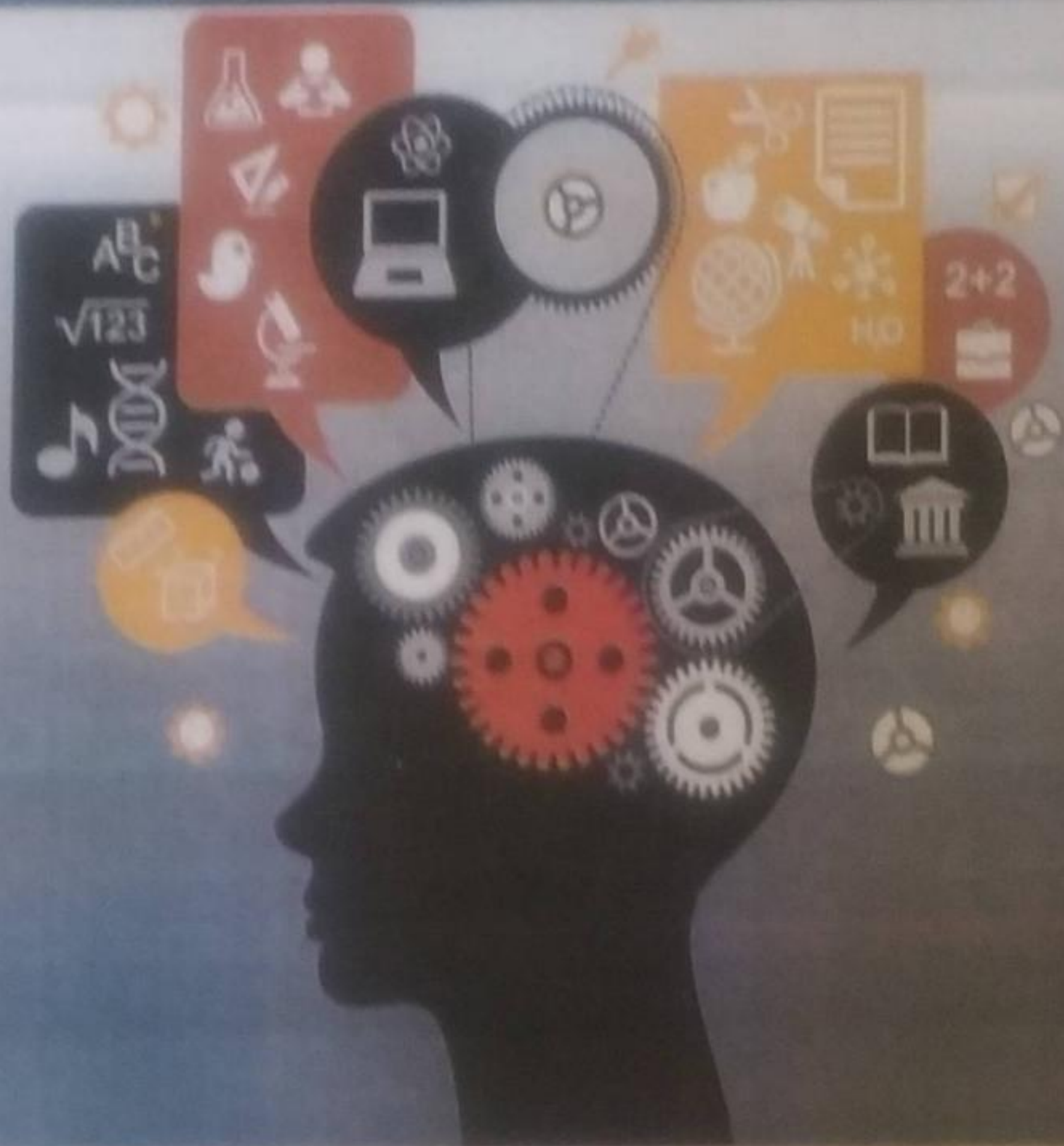

INTERNATIONAL JOURNAL OF SCIENTIFIC RESEARCH IN SCIENCE, ENGINEERING AND TECHNOLOGY

















Volume 1 Issue 2 March-April 2015





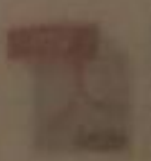







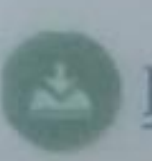

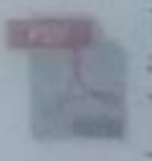

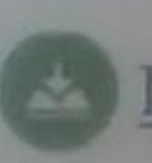

Email: editor@ijsrset.com, ijsrset@gmail.com

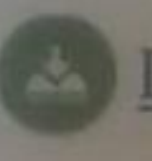

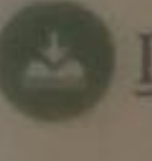

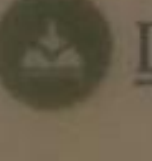

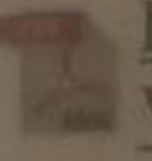

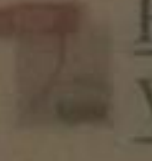
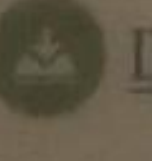









[Home](#) > [Volume 1, Issue 2](#)

[Complete Version](#)

Volume 1, Issue 2, March-April-2015

Sr. No	Title & Authors Name	Page(s)
1	Lossless Compression for Raster Maps Based On Mobile Phyo Phyo Wai, Nyein Aye, Mie Mie Khin  Abstract  PDF View  Download Cite this Article	1-6
2	Processing and Characterization of Thermoplastic Starch / Polypropylene Blends Obasi, H. C., Igwe, I. O., Ogbobe, O., Aharanwa, B. C., and Egeolu, F. C.  Abstract  PDF View  Download Cite this Article	7-13
3	Child Behaviour Monitoring System Using Android Application Venkatraman. R, Vikram.V, Surendhar. R, Sathish Saravanan.P  Abstract  PDF View  Download Cite this Article	14-15
4	Preventing Side-Channel leaks in Web Traffic using SVSD Akshaya A.K, Pavithra P, Anitha Sahaya Mercy P  Abstract  PDF View  Download Cite this Article	16-19
5	Lone Traveler Security M. Ram Prasad, V. Ramesh Mahadevan, C. Santosh Kumar , Mr. U. Arul  Abstract  PDF View  Download Cite this Article	20-22
6	Ontology Based Recovery of Geographic Information Services S. Nivedha, B. Sneha, Sonakshi Bhatooa, M. Gayathri  Abstract  PDF View  Download Cite this Article	23-26

7	<p>A Review on Packed Bed Removal of Organic Matter from Wastewater Sunil Jayant Kulkarni</p> <p> Abstract  PDF View  Download Cite this Article</p>	27-30
8	<p>Building Virtual Machine Instance, Compatible with User's Web Application in Openstack Cloud Provider Ms. Srinija T, Ms.Sangeetha T, Ms. Sanjena K, Ms. Arulmozhi Arasi D S</p> <p> Abstract  PDF View  Download Cite this Article</p>	31-34
9	<p>Identity Based Encryption for Securing Publish Subscribe System Harismita. H, Laavanya.R, Meenaa.R, Kalai Selvi</p> <p> Abstract  PDF View  Download Cite this Article</p>	35-40
10	<p>Tourist Suggestion Pocket by Tangle Process R.AshwiniSujitra , K.Charumathi , P.AnithaSahaya Mercy</p> <p> Abstract  PDF View  Download Cite this Article</p>	41-42
11	<p>On Interval Valued Intuitionistic(S,T)-fuzzy Hv-ideals Arvind Kumar Sinha, Manoj Kumar Dewangan</p> <p> Abstract  PDF View  Download Cite this Article</p>	43-48
12	<p>Identification and Avoidance of DDoS Attack for Secured Data Communication in Cloud Divya G., Archana S. , Dhanalakshmi S. , Divya D.</p> <p> Abstract  PDF View  Download Cite this Article</p>	49-57
13	<p>Secure Storage using TPC-C in Cloud A. Azarudeen, N. Ganesh, R. Dinesh, Mr. R. Ramakrishnan</p> <p> Abstract  PDF View  Download Cite this Article</p>	58-61
14	<p>Security Enhancement and Data Integrity Checking In Multi-Cloud Storage Lakshmi Priya. S, Jyothi Lakshmi C, Abirami G</p> <p> Abstract  PDF View  Download Cite this Article</p>	62-65
15	<p>Data Hiding in AVI Video Files Using Multivariate Regression and Flexible Macro block Ordering Siva Kumar L, Singara Srikanth, Nathiya Devi P</p>	66-70

	 Abstract  PDF View  Download Cite this Article	
91	A Ranking Based Combined Approach for Recommending Travel Packages N. R. Rejin Paul, G. Karpagam, R. Sindhuja, S. Yamini  Abstract  PDF View  Download Cite this Article	460-466
92	An Efficient Energy Optimization in Routing Protocol Wireless Adhoc Network Amit Kumar Gupta, Shahid Sagar, Prerna Trivedi  Abstract  PDF View  Download Cite this Article	467-470
93	 Development and Implementation of a Solar-Powered Automated Irrigation Control System for Maize Crop Grown in Loamy Soil Ibrahim A. G., Mosadomi, T. J., Odekunle, M. O.  Abstract  PDF View  Download Cite this Article	471-478
94	Design of Sequential Circuits Using MV Gates in Nanotechnology Bahram Dehghan, Ahad Salimi  Abstract  PDF View  Download Cite this Article	479-485
95	Knowledge Management System development by deploying ART Artificial Neural Networks Algorithm Chris M. Jayachandran, Dr. Shyamala Kannan  Abstract  PDF View  Download Cite this Article	486-492

Contact Us

Important Links

[Membership Form](#)

ijsrset@gmail.com
editor@ijsrset.com

[Privacy Policy](#)
[Copyright and Disclaimer](#)



17710

Copyright © 2014 - International Journal of Scientific Research in Science, Engineering and Technology

Science

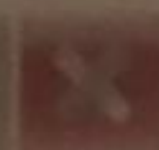

Manuscript Reviewed

~~ibsa~~

Fri, Mar 27, 2015 at 3:43 AM

Editor

<ijrset@gmail.com>

To: ibrahimaku@futminna.edu.ng

[Reply](#) | [Reply to all](#) | [Forward](#) | [Print](#) | [Delete](#) | [Show original](#)

Dear Author,

Congratulation,

Research paper titled: "Development and Implementation of a Solar-Powered Automated Irrigation Control System for Maize Crop Grown in Loamy Soil." (Manuscript Number: IJSRSET152285) has been reviewed by reviewers and recommended to publish in International Journal of Scientific Research in Science, Engineering and Technology (IJSRSET) Volume I Issue I (Jan - 2015).

Thank you for submitting your work to our journal.

With Best Regards,

Editor-In-Chief

Advisory/Editorial Board

- Dr. Manish Shorey, Bangalore, Karnataka
- Prof. Bhavesh Kataria, Gandhinagar, Gujarat, India
- Dr. M. K. Rameshaiah, Bangalore, Karnataka
- Dr. V. S. Majumdar, Pune, Maharashtra
- Prof. Shardul Agravat, Surendranagar, Gujarat, India
- Dr. Sundeep Sinha, Delhi, Gujarat, India
- Dr. Ashish Sharma, Delhi, Gujarat, India
- Prof. Vaishali Kalaria, RKU, Rajkot, Gujarat, India
- Prof. H. B. Jethva, L. D. College of Engineering, Ahmedabad, Gujarat, India
- Prof. Bakul Panchal, L. D. College of Engineering, Ahmedabad, Gujarat, India
- Prof. Bhavesh Prajapati, Government MCA College Maninagar, Ahmedabad, Gujarat, India
- Prof. Amod Pandurang Shrotri, Shivaji University, Kolhapur, Maharashtra, India
- Prof. Sunil Kulkarni, Datta Meghe College of Engg. Airoli, Mumbai, Maharashtra, India
- Prof. Atishey Mittal, S.R.M. University, NCR Campus, Modinagar, Ghaziabad, Uttar Pradesh, India
- Dr. Syed Umar, Dept. of Computer Science and Engineering, KL University, Guntur, Andhra Pradesh, India
- Dr. S. Ahmed John, Jamal Mohamed College, Tiruchirappalli, India
- Prof. S. Jagadeesan, Nandha Engineering College Erode, Tamil Nadu, India
- Dr. Faisal Talib, IIT Roorkee(PhD), Aligarh, Uttar Pradesh, India
- Prof. Joshi Rahul Prakashchandra, Parul Institute of Engineering & Technology, Vadodara, Gujarat, India
- Dr. Aftab Alam Tyagi, Department of Mathematics, SRM University NCR Campus, Uttar Pradesh, India
- Dr. Sudhir Kumar, Department of Mathematics, S.D. (P.G.) College, Uttar Pradesh, India
- Dr. Rimple Pundir, Nagar, Uttar Pradesh, India
- Prof (Dr.) Umesh Kumar, Dept of Science & Technology, Govt. Women's Polytechnic, Ranchi, Jharkhand, India
- Abhishek Shukla, R. D. Engineering College Technical Campus, Ghaziabad, Uttar Pradesh, India
- Dr. Balram Panigrahi, Soil & Water Conservation Engineering, College of Agricultural Engg. & Techn. Orissa University Of Agriculture & Technology, Bhubaneswar, Odisha, India
- Dr. Anant Lalchand Chaudhari, Department of Electronics, Arts, Science & Commerce College, Chopda, Jalgaon, Maharashtra India
- Dr. N. Pughazendi, Computer Science and Engineering, Panimalar Engineering College Chennai, Tamilnadu, India
- Dr. V. Ananthaswamy, Department of Mathematics, The Madura College, Madurai, Tamil Nadu, India
- Rakesh K. Bumataria, Mechanical Engineering, Marwadi Education Foundation's Group of

Institutions Rajkot, Gujarat, India

- Dr. Arvind Bijalwan, Indian Institute of Forest Management (IIFM) (Ministry of Environment & Forests, Govt. of India) Bhopal, Madhya Pradesh, India
- Sharvil D. Shah, Mechanical Engineering Dept. Parul Institute Of Engg. & Tech, Vadodara, Gujarat, India

International Advisory/Editorial Board

- Prof. Sundeep Singh, Mississauga, Ontario, Canada
- Dr. Scheiber Lazarova, Germany
- Dr. Reckeweg Ulmet, Germany
- Dr. Carly Pouladi, Vancouver, Canada
- Dr. Gheorghe Nagy, Romania
- Dr. Anja Siersbæk, Odense, Denmark
- Dr. Daniala Paoloni Zurich, Switzerland
- Dr. Joseph Easton, Boston, USA
- Dr. Eliana Lu, USA
- Dr. M. Chithirai Pon Selvan, School of Engineering & Information Technology, Manipal University - Dubai
- Dr. Md. Abdullah Al Humayun, School of Electrical Systems Engineering, University Malaysia, Perlis, Malaysia
- Dr. V. Balaji, Bahir Dar University, Bahir Dar, Ethiopia
- Lusekelo Kibona, Department of Computer Science, Ruaha Catholic University (RUCU) , Iringa, Tanzania
- Dr. Mohamed Abdel Fattah Ashabrawy, Reactors Department, Atomic Energy Authority, Egypt
- Mohammed Noaman Murad, Department of Computer Science, Cihan University Erbil, Kurdistan Region, Iraq
- Dr. Abul Salam, UAE University, Department of Geography and Urban Planning, UAE
- Md. Amir Hossain, IBAIS University/Uttara University, Dhaka, Bangladesh
- Dr. Amer Taqa, Department of Dental Basic Science College of Dentistry, Mosul University, Iraq

Development and Implementation of a Solar-Powered Automated Irrigation Control System for Maize Crop Grown in Loamy Soil.

Ibrahim A. G.^{*1}, Mosadomi, T. J.², Odekunle, M. O³

^{1,2} Department of Physics, Federal University of Technology, Minna, Nigeria
³ Department of Geography, Federal University of Technology, Minna, Nigeria

ABSTRACT

This work presents a microcontroller based system which makes use of soil moisture sensors and plant growth models to develop irrigation schedules for maize crop grown in loamy soil. The methodology adopted for this work involves field survey, electronic circuit design, implementation and testing. The field studies provided details on the crops root depth pattern and water requirement throughout its growth period. With a dual power source of solar and a.c power supply, moisture sensor, microcontroller, LDR, LCD and sprinkler units; the microcontroller would permit the sprinkler to start and stop at given times during each growth period when the soil moisture falls below a predetermined level as sensed by the soil moisture sensors. Also included in this design is a DTMF decoder unit that permits interaction with the farmer on the current state and step to be initiated by the device via a remote phone. Test results indicate effective irrigation throughout the maize crop's life cycle, bringing about improved crop yield/quality, water and energy conservation.

Keywords: Irrigation, Loamy soil, Microcontroller, Maize crop, Soil sensor.

I. INTRODUCTION

Modern agriculture require specialized knowledge, hence depends on engineering and technology, and on the physical sciences for maximum results. One of such specialized aspect is irrigation. Irrigation is the artificial application of water to the land to assist in the growing of agricultural crops [1]. Irrigation has an extreme advantage which is that it produces twice the yield of non irrigated fields although presents about 18 per cent of all land under cultivation [2]. However, it can waterlog soil or increase soil salinity to the plant such that the crops are damaged or destroyed if not managed properly [3] and [4]. A good irrigation system apart from supplying water to crops should also be water economical [5]. Water in most part of the world is scarce especially during the dry season [6], hence the need to maximise whether it is natural or artificial [1] and [7]. Since water requirements differ from crop to crop with this requirement varying with age (root depth) [8], it was the reason this device was made to be crop

specific by selecting a popular crop with a short life cycle of about 120 to 150 days; the maize crop. Maize (zea-mays) is one of the most important cereals both for human and animal consumption and is grown for grain and forage. It contains about 10 percent protein, 4 percent oil, 70 percent carbohydrate, 2.3 percent crude fibre, 10.4 percent albuminoides, 1.4 percent ash [9]. Also, the water retaining capability of the soil in which a crop is grown differs from soil to soil [10]. For this reason the device was again made to be soil specific by selecting a popular soil type; the loamy soil. The crop specific and soil specific nature of such a device however provide a model for other crop and soil types [11]. In this work, electronics was applied in irrigation control to develop a more effective irrigation system that is automated, microcontroller manage, soil moisture sensor based and interactive with the farmer. It maintains the desired soil water range in the root zone for optimal plant growth, ensures water usage efficiency, minimum loss of water through evaporation or percolation into the ground, improved crop yield

and quality, water and energy conservation, less manpower and low production costs.

II. METHODS AND MATERIAL

The methodology adopted for this work is as follows: field survey, electronic circuit design, implementation and testing

2.1 Field survey

In a work of this nature, field experimentation is necessary for a correct simulation of realistic phenomenon [11] and [12]. In this case, a field study was carried out to match the maize crop's water demands with its growth period. Since the crop's water demand changes over time as the root zone increase over its growth cycle. A knowledge of the rate at which the root zone of the crop increases over time will serve as a guide for the irrigation scheduling throughout the plant's growth cycle. To do this, a critical assessment of the root growth pattern was done so as to ascertain the right quantity of water required at specific depth. In order to achieve this, some maize seeds were planted on separate rows on a loamy soil garden and specific quantity of water supplied at different growth periods using manual irrigation for each row. The usual cultural practices for maize were observed except that certain growth periods were under irrigated, moderately irrigated or over irrigated. This was done to assess the best quantity of irrigated water for every growth period. Evening times were chosen for irrigation due to the fact that the water will have enough time to percolate to desired root depth with little loss to evaporation [13]. The measurement of the degree of resistance offered by the moist soil was done with the aid of an ohmmeter and moisture sensors, while observing the root growth patterns, quantity of water supplied and the yield/quality of the crop over time. In order to know the root growth pattern of the crop, one pair was carefully uprooted per week and its root depth measured. Table 1 shows the result obtained for the root depth spanning through the growth stages of the maize crop.

Table 1: Root Depth of Maize Crop Corresponding to Growth Stages.

Growth Stages	Period (day)	Root Depth (cm)	Average Depth(cm)
Establishment Period	15-25	5-7	6
Vegetative Period	40-65	8-10	9
Flowering Period	55-85	12-15	13.5
Yield formation Period	90-125	15-17	16
Ripening Period	100-150	17-18	17.5

Vital results from the field work and corroborated with existing knowledge has it that, water deficit during the flowering period result in reduction in grain number per cob [14], water deficits during the yield formation period leads to reduction in grain size [15], whereas, water deficit during the ripening period has little effect on grain yield. Maize appears relatively tolerant to water deficits during the vegetative and ripening periods. Water logging should be avoided, particularly during the flowering and yield formation periods as water logging during these periods can reduce grain yields by 50 percent or more. The row with the best yield along with its water scheduling was adopted for this work. The resistance values corresponding to the soil moisture condition when irrigation will be required was measured as 0.95 Ω while those for over irrigation, moderate irrigation and under irrigation are 0.2 Ω , 0.35 Ω and 0.5 Ω respectively.

2.2 Electronic Circuit Design

The result of the field studies alone side other previous information will now be electronically incorporated into the design to create a more effective, water economical and interactive irrigation control system. The sections of the design are explained below.

Power supply

The power supply is a unit capable of supplying dc voltage and current to an electronic circuit under test [16]. This equipment is expected to be used in both urban and rural areas which are characterized by the availability and unavailability of public power supply respectively. Also considering the abundant solar energy potentials in certain regions, generation of electricity from the sun will be more reliable [17] and

[18]. Therefore a dual power supply system comprising the solar power and the conventional power supply circuits were designed. The solar power section comprises of three constituents namely: the solar panel, solar charge controller and the battery. The enormous renewable energy of the sun was harnessed using an 18 V, 50 W monocrystalline solar panel positioned at the right tilted angle of 10° (latitude of location) due south for a maximum solar gain. From power analysis of the device, the power requirement of constituent sections is 25 W with the maximum voltage and current ratings of 10 V and 2.5 A. The resultant 18V, 50 W capacity solar panel was used to charge a 12 V, 7.5 A battery. The solar panel, battery and load (successive sections) was regulated by a 12 V, 10 A solar charge controller. While the conventional power supply section is made up of a 220 - 10 V step down transformer for stepping from mains, bridge rectifier for conversion to dc, a 50 V, 3300 μ F capacitor (C1) for elimination of ripples and a 7805, 7809 and 7810 regulators to peg the output at 5 V, 9 V and 10 V respectively as will be required by subsequent sections. A socket was provided just before the regulator where either the solar or a.c power supply can be plugged in.

Signal flow through successive sections of a device is simplified using a block diagram [19]. The block diagram of the system is shown in figure 1.

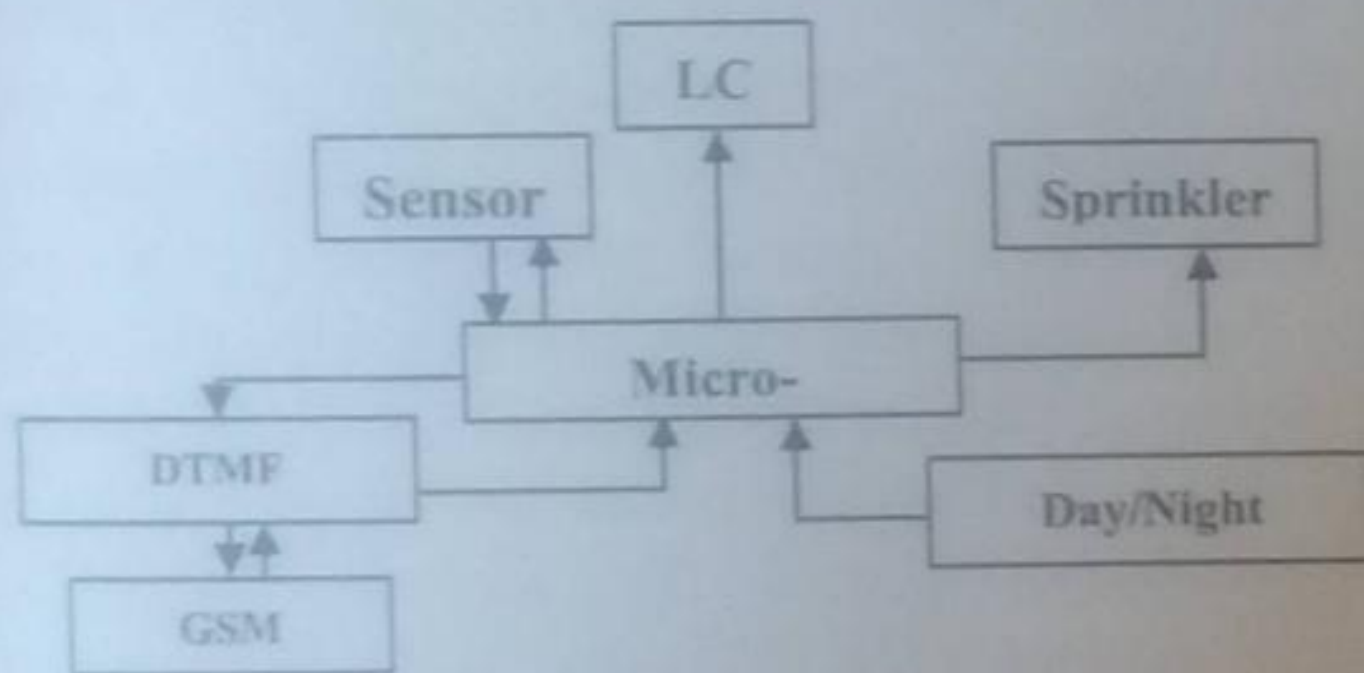

Figure 1: Block diagram of the irrigation control system.

Each section will be discussed one after the other.

The Sensor Unit

Sensors are incorporated into devices to detect specific characteristics of their environment [20]. In this work, the sensor unit has a responsibility of monitoring the level of soil moisture at the root zone of the crop. The sensor is sunk into the ground so that the contact points

could monitor the level of moisture in the soil. It works by the principle of electrical conductivity. When the moisture content is high, conductivity is high (water being a conductor of electricity) and resistance is low while for low moisture content, conductivity is low and resistance is high. Resistivity of a material ρ , quantifies how strongly the given material opposes the flow of electric current, while conductance σ , measures a material's ability to conduct an electric current. Both quantities are related as shown in equation (1).

$$\sigma = 1/\rho \quad (1)$$

where σ is the conductivity of the soil and ρ is the resistivity of the soil [21]. When water falls below the predetermined minimum level, the sensor senses a high resistance and instructs the microcontroller (a successive section) to take action by sprinkling water of specific quantity. The calibration of the sensor is dependent on the rooting characteristic of the crop and for this reason; the field survey above was conducted for an assessment of the changes in the root (soil) zone and water demand over the life cycle of the crop. A resistance of 0.95Ω corresponds to the moist condition of the soil when irrigation will be required. Result of the field survey displayed in Table 1 was used to calibrate the sensor. The kind of sensor used in this design is a 20 cm long wooden bar, having metallic thumb tacks fixed at some determined points in it to serve as the contact points. With reference to table 1, the period 1 to period 5 of the plant's growth process corresponds to the average root depths of 6, 8, 13.5, 16 and 17.5 cm respectively, so metallic thumb tags were inserted at these intervals and sunk into the ground to help ascertain the moisture condition of the crop per time and throughout the season. Figure 2 is a schematic diagram of the sensor.

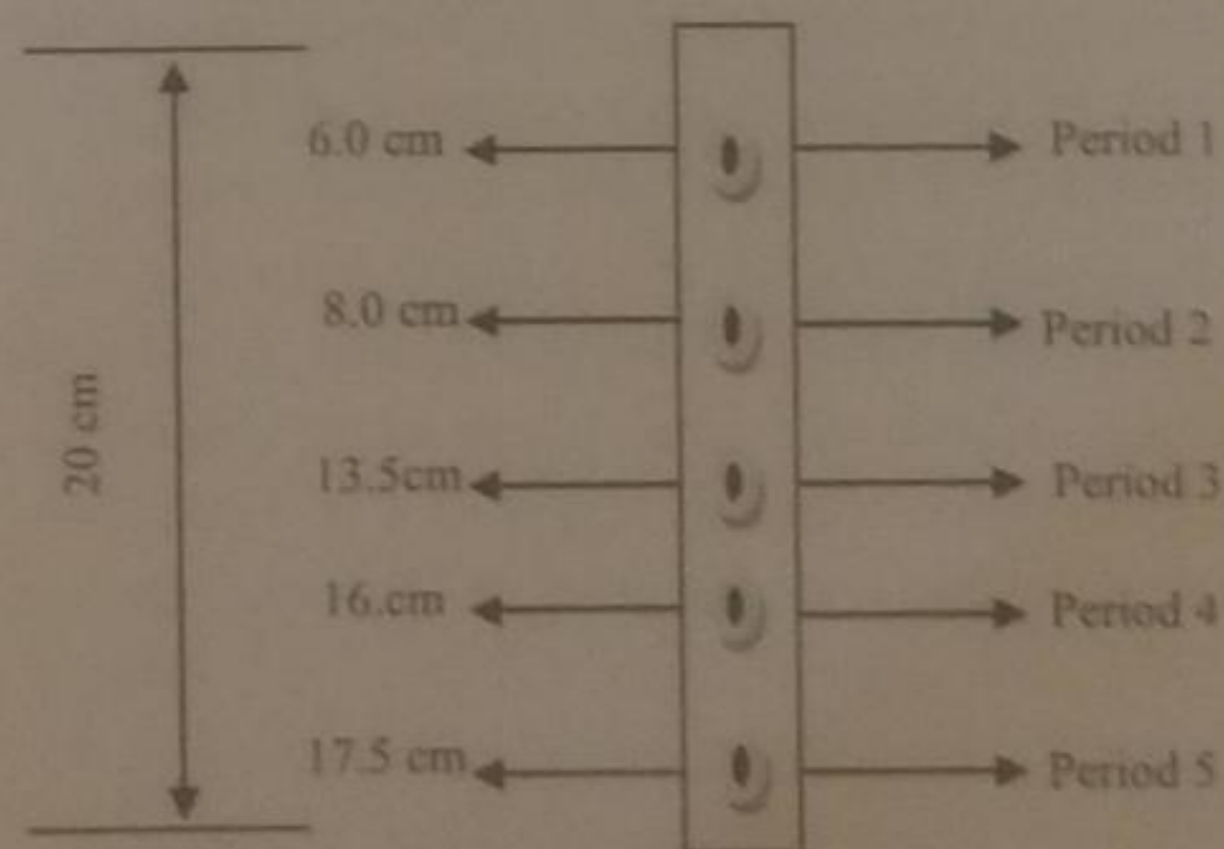

Figure 2: Calibration of Sensor

At the maturity stage, water has little or no effect on the crop, therefore period 4 and 5 were merged together. Each of the metallic thumb tag for period 1 to 4 of the sensor SW1 were directly connected to pin 1, 2, 3, 4 of the microcontroller. LED's D2 to D5 were incorporated and are to turn ON at same growth period that sensor 1 to 4 are respectively to monitor. The second sensor (SW2) is connected to pin 11, 12, 13 and 26 of the microcontroller respectively. The microcontroller via its programmed instruction, triggers each sensor to function when its growth period is due while the sensors also feeds the microcontroller of the moist condition around the root zone. If below the predetermined value of 0.95Ω , water is sprinkled until the resistance of the soil drops to the predetermined value for the current growth period before the microcontroller takes appropriate action by tripping OFF the sprinkler unit.

The Microcontroller Unit

The microcontroller is an embedded system in a chip which executes instructions based on the programme written on it. This is the 'brain' of the system as it controls and processes input signals, giving the appropriate output signals to the interconnected units. In this work, the microcontroller used is the AT89C52 from 8051 family. The microcontroller was programmed using assembly language through a hardware called top win universal programmer. Pin 40 serves as the Vcc, and powered by a 5 V regulator from the power unit. The controller uses a 12 MHz crystal oscillator as its operating frequency. This is based on the delay frequency needed for this design. With a 12 MHz crystal, the microcontroller unit is capable of executing one million instructions per second [22]. The AT89C52 microcontroller factory connection as implemented in this design is shown in figure 3.

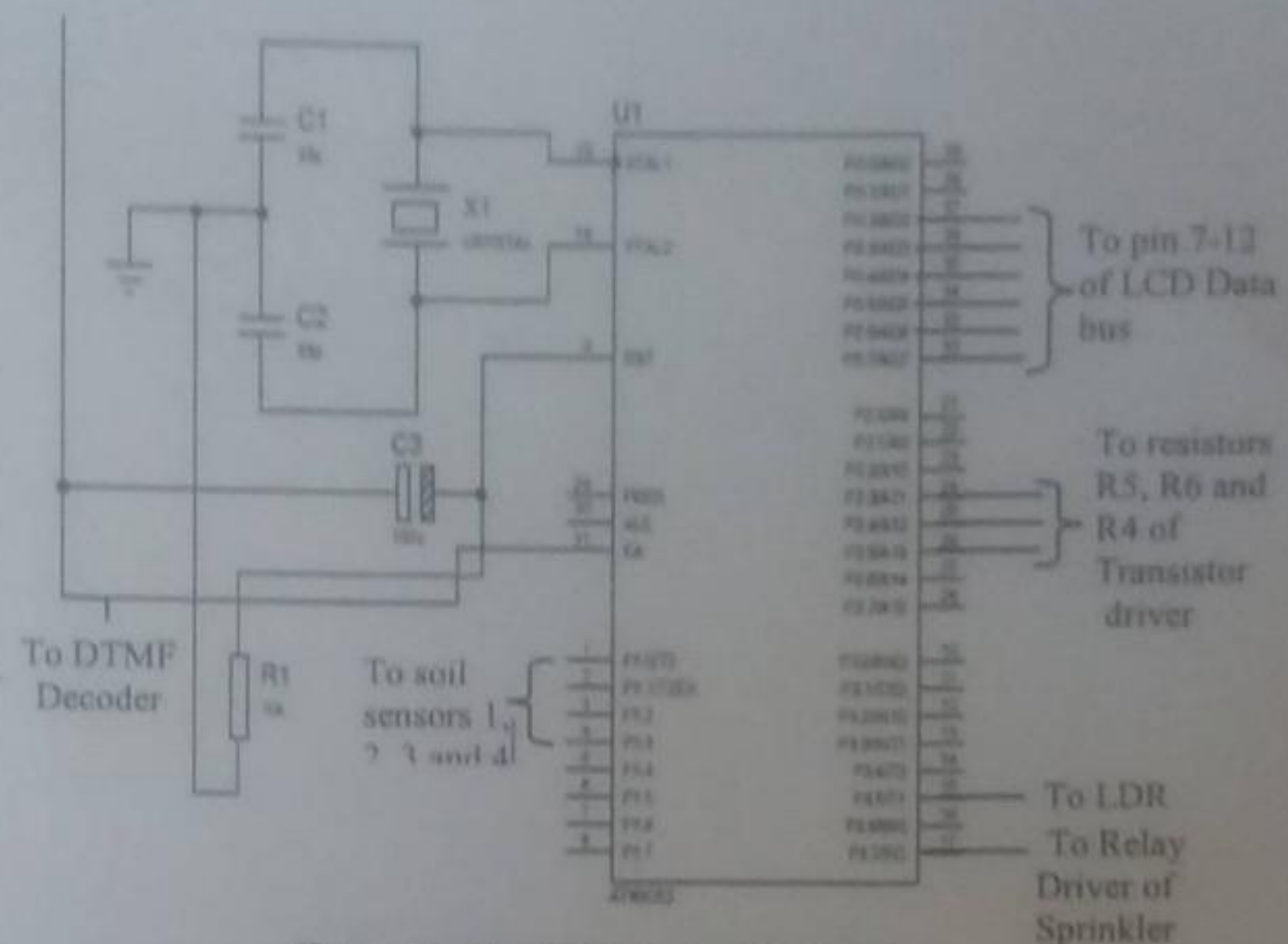

Figure 3: The Microcontroller Unit

The microcontroller exercises electronic control over other sections it communicates with through its pin connection to such sections. With the connection of figure 3, the microcontroller carries out the following functions:

- 1 Runs the embedded software code that controls the system.
- 2 Triggers and monitors the state of the sensor.
- 3 Sends and receives signal from the GSM phone through the DTMF decoder.
- 4 Receives signal also from the LDR.
- 5 Sends signal to the sprinkler on when to sprinkle and when to stop.
- 6 Sends signal to the LCD for display of the operation being performed or intended at a particular time.

The Dual Tone Multi-Frequency (DTMF) Decoder

The DTMF is a Dual Tone Multi-Frequency receiver which is capable of decoding a 16 bit code from a GSM phone and converting it to a 4 bit corresponding binary code, and then latches it on its output pins. It serves as the communication link between the microcontroller and a remote GSM phone to be in possession of the farmer. A quartz crystal oscillator of 3.592 MHz is connected at its pin 7 and 8 to provide its operating frequency. A 5 V source from the power supply unit is connected to pin 18 of the decoder, and the pin 9 to the ground. Pin 1 and 2 serve as its input. Pin 11, 12, 13 and 14 of the decoder are its output and are connected to port1 bit 0, port1 bit 1, port1 bit 2 and port1 bit 3 respectively. Pin 15 serves as the signal indicator; this pin only goes high whenever the DTMF decoder

registers a valid tone received from a remote GSM phone. It then latches its output on the microcontroller's pin 10 and 31 for onward action. The point of connection is shown in the general circuit diagram of figure 8.

The Global System for Mobile Communications (GSM) Module

The GSM phone serves as the remote phone to the DTMF receiver. The phone is set on auto answer so as to automatically receive any incoming call relayed from the DTMF module. The remote phone would be expected to key-in the required code for the microcontroller to perform a certain tasks to operate the sprinkler. The phone shall receive a message "about to sprinkle" from the microcontroller through the DTMF. The farmer has a choice of replying "OK" to commence sprinkling immediately or ignore the message and postpone sprinkling for another thirty minutes. This period is to allow the farmer ample time to return to the farm and supervise the sprinkling process when necessary. Once the remote phone is through with the operation, the operator can hang up. The microcontroller also interacts with the remote GSM phone on the state of the soil moisture sensors.

To configure the GSM phone to undertake this task, it needs to be driven. For this reason, a pnp transistor (BC557) is connected to the 'select' button of the phone to automatically perform this required operation; one lead of the transistor to the negative point and the other lead to the positive point. Then the transistor is connected through a 1.5 kΩ resistor to port 2 bit 4 (pin 24) of microcontroller chip. The same connection is done with two other transistors to the 'down' button and the 'back' button of the receiver phone, and then to the port 2 bit 6 (pin 25) and port 2 bit 5 (pin 26) of the microcontroller respectively. The emitter of the transistors were tied together and connected to the positive points while the collectors were connected to the negatives of appropriate buttons. Figure 4 shows how the phone transistor drivers were connected to the GSM phone.

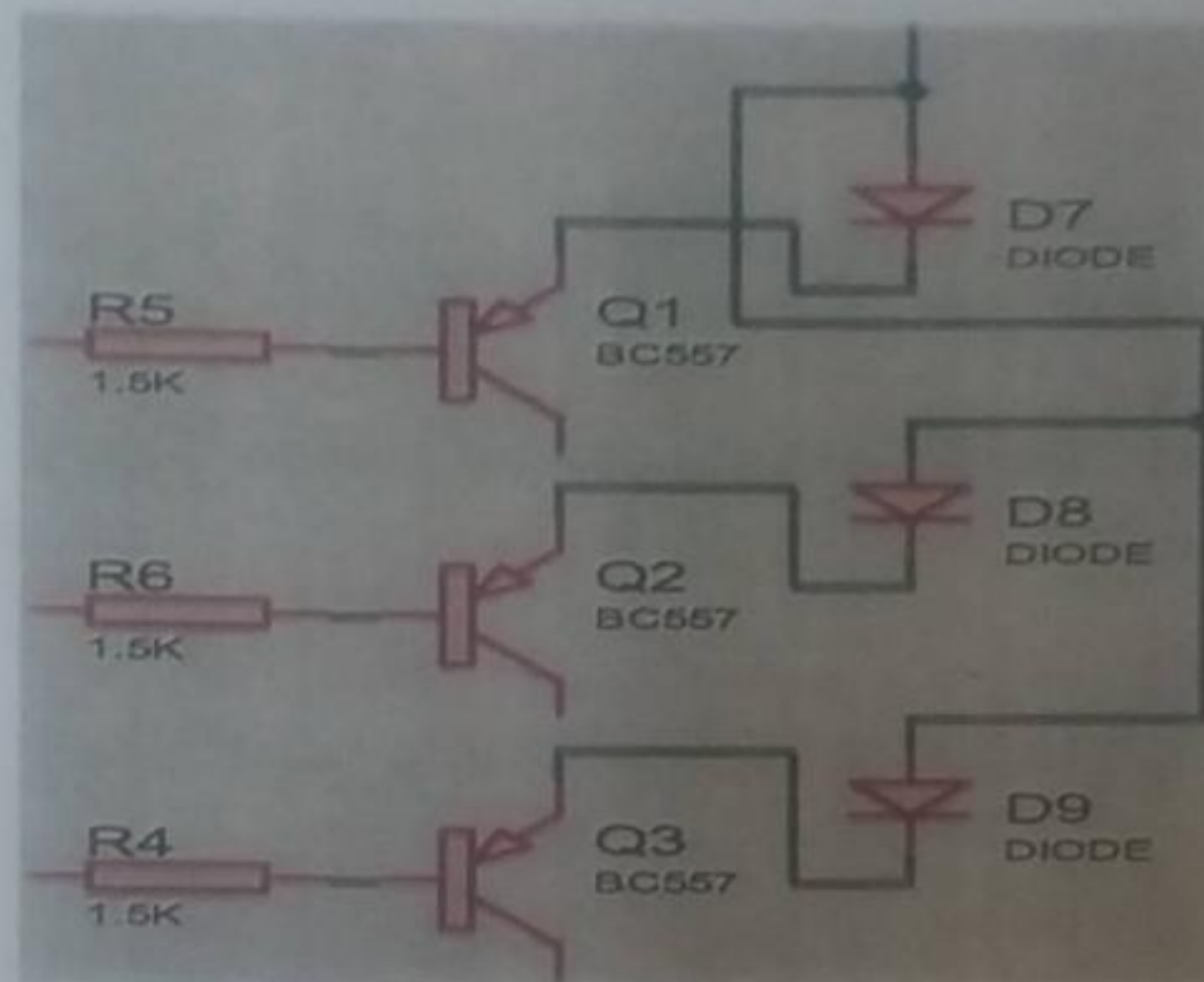

Figure 4: Phone Transistors Driver

The Light Dependent Resistor (LDR) Unit

The LDR is connected to the microcontroller port 3 bit 4 (pin 15), and the other pin is tied to the ground. In the day time, port 3 bit 4 is pulled low because the internal resistance of the LDR is low (about 200 Ω) therefore, the controller is aware that its day. In the evening when, the LDR's resistance rises to about 2 MΩ, this sends a pulse to the microcontroller through port 3 bit 4 that its evening and the controller acts appropriately. The controller on sensing evening

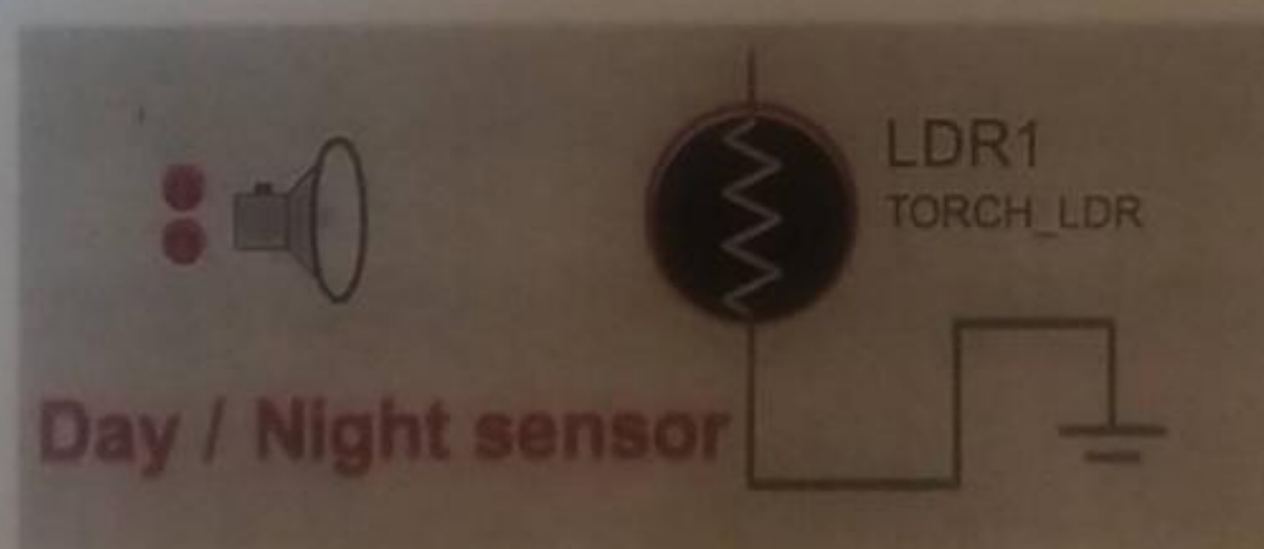

Figure 5: The Light Dependent Resistor.

triggers the sprinkler to come up. In order to achieve this, the photo limit was earlier adjusted by varying the variable resistor to the 2 MΩ value. Figure 5 shows the Light Dependent Resistor.

The Sprinkler Section

This section comprises of the motor pump, relay and its driver unit. They become active only when the LDR senses evening and sends a pulse to the microcontroller which in response turns ON the sprinkler section. The sprinkler is powered via the relay (RL1) to serve as control switch. As soon as the relay toggles, the motor

...pumps out water for sprinkling of the soil around the
 ...not zone until its moisture content reaches the desired
 ...level as sensed by the soil moisture sensor which sends
 ...feedback to the microcontroller. A 10 V pump was used
 ...with an attached horst connecting from the water tank to
 ...the crop's base. The sprinklers relay is driven by a BC
 ...57 pump transistor having a limiting base resistance of 1
 ...k Ω (R7). The base of the transistor is connected to pin
 ...17 of the microcontroller from where the section is
 ...triggered. The circuit diagram of the sprinkler section is
 ...shown in figure 6.

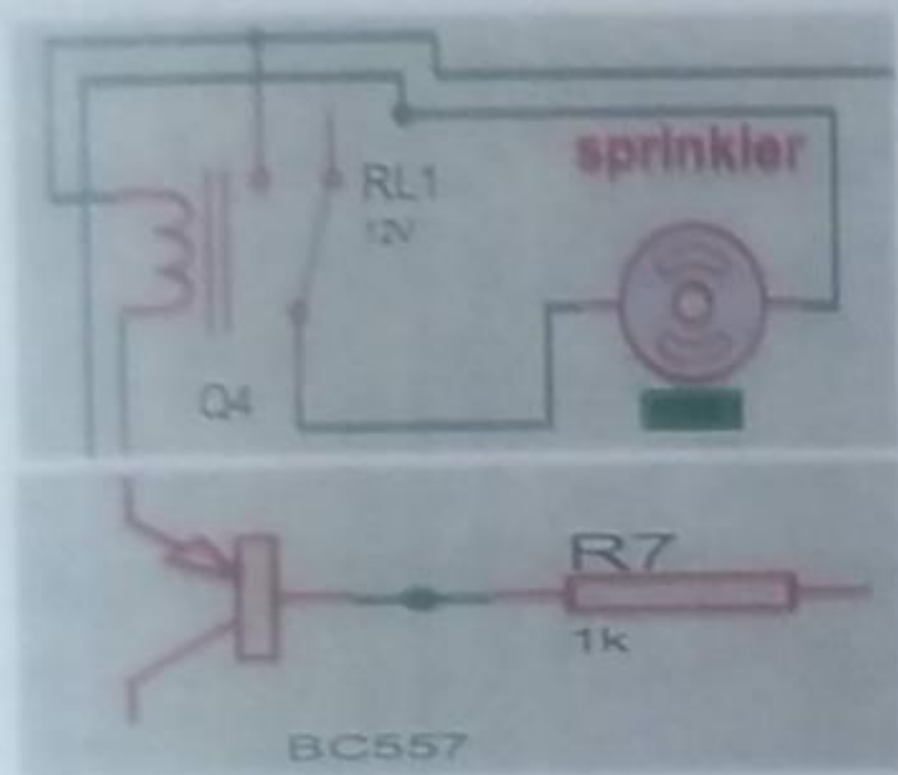

Figure 6: The Sprinkler Section.

The Liquid Crystal Display (LCD) Unit

The LCD used is a 74HD green phase 16 x 2 type, meaning it can only display a maximum of 32 characters in two lines, with 16 in each line. The LCD data port is connected to port 0 of the microcontroller in the following way: The LCD data/bus line (pin 7-14) is connected to microcontrollers pin 32-39 respectively. While the control pins (pin 4-6) is connected to microcontrollers pin 21-23 respectively. LCD pin 1 and pin 2 are its power supply (to V_{CC}), pin 3 is the contrast variable resistor (RV1) for setting the brightness of the characters displayed to one's desire. Figure 7 shows the LCD connection.

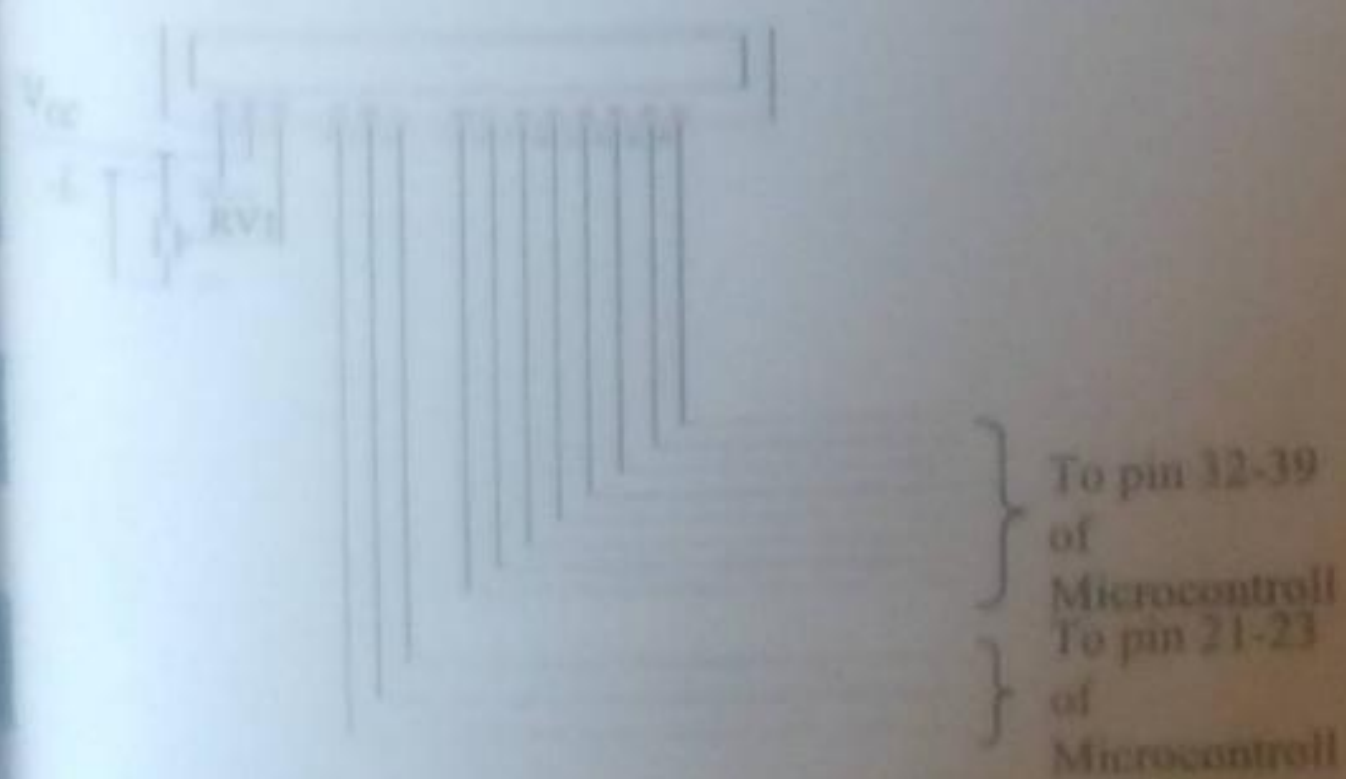

Figure 7: The Liquid Crystal Display

The display on the LCD include: "Hello", "Irrigation Control System", "Running period 1", "Running period 2", "Running period 3", "Running period 4", "about to sprinkle", "Sprinkling in progress", soil moisture content: High", soil moisture content: Low" and so on. The overall circuit diagram of the solar powered automated irrigation control system for maize crop grown in loamy soil is shown in figure 8.

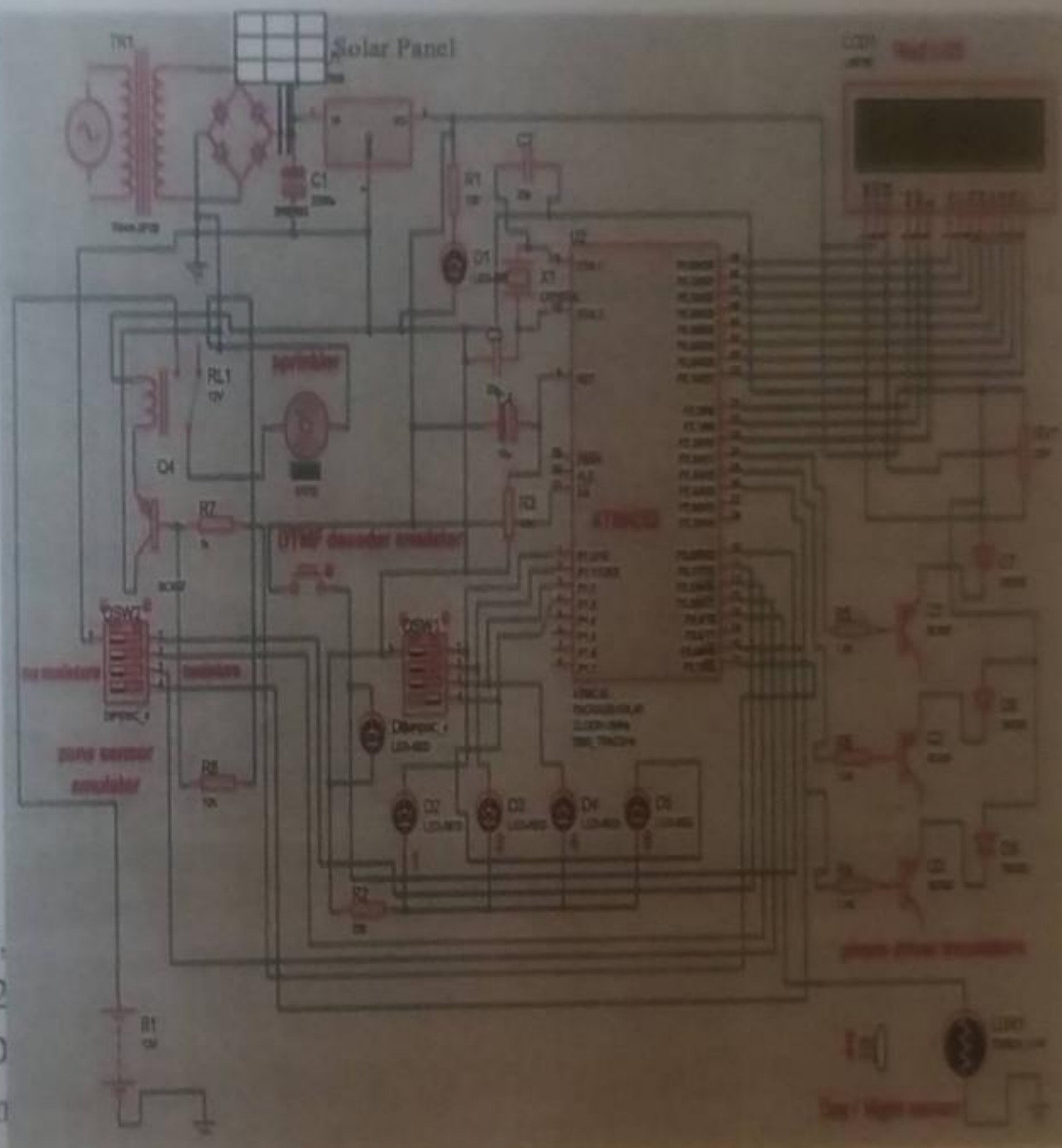

Figure 8: Overall Circuit Diagram of the Device

2.3 Implementation

The electronic components and parts of the design in figure 8 were carefully arrived at through design calculations or standard functions. They were electronically assembled in line with circuit schematics and cased. The LDR was separately cased in a transparent box to control the illumination around it. The solar panel was raised to a height of 4.0 m above the ground and tilted to 10° due south with the aid of a metal rod for maximum solar exposure. The solar panel also serves as shelter for the casing which is attached just below the solar panel. A plastic pipe connects from the water tank located at the base to the sprinkler's pump through the inlet and another pipe which is underground connects from the outlet to the soil surface, close to the crop's root zone. The wiring from the soil

moisture sensors to the microcontroller were neatly packaged to follow along the outlet pipe back to the pump where they are plugged into external sockets. This prototype was implemented with two sensors, two outlet pipes and connected to two maize crops. In field testing, same arrangement is maintained but the outlet pipes are duplicated around the farm, maintaining same distance to the crop. Since mono cropping (only maize) is practiced with all the crops planted same day, at equal depth, equal spacing and same soil type (loamy soil); the moisture condition of their root zone will be the same. Therefore only two maize crops were used as samples and to which the soil moisture sensors were connected to their root zones for an assessment of moisture condition at other root zones.

III. RESULTS AND DISCUSSION

The field assessment shows that times of LCD display of soil moisture content: "High", and soil moisture content: "Low" correspond to periods when the soil at the root zone are getting a little dried and when the soil is moist enough respectively. Also is the DR section which constantly turns ON the sprinkler's pump at about 4.00 to 5.00 pm in the evenings. Also striking is the level of interaction between the system and the remote phone. The farmer is kept abreast on happenings at the root zone, current growth period and notification of intention to sprinkle. The reply which delays or instantly initiates the sprinkling process was tested at evenings by sending a short code "OK" which witnessed instant sprinkling and ignoring the message which witnessed a delay of thirty minutes before sprinkling. The quantity of water sprinkled per round and per stand for each growth period were separately collected and measured. The graph of figure 9 shows the variation in the quantity of water sprinkled for each growth period.

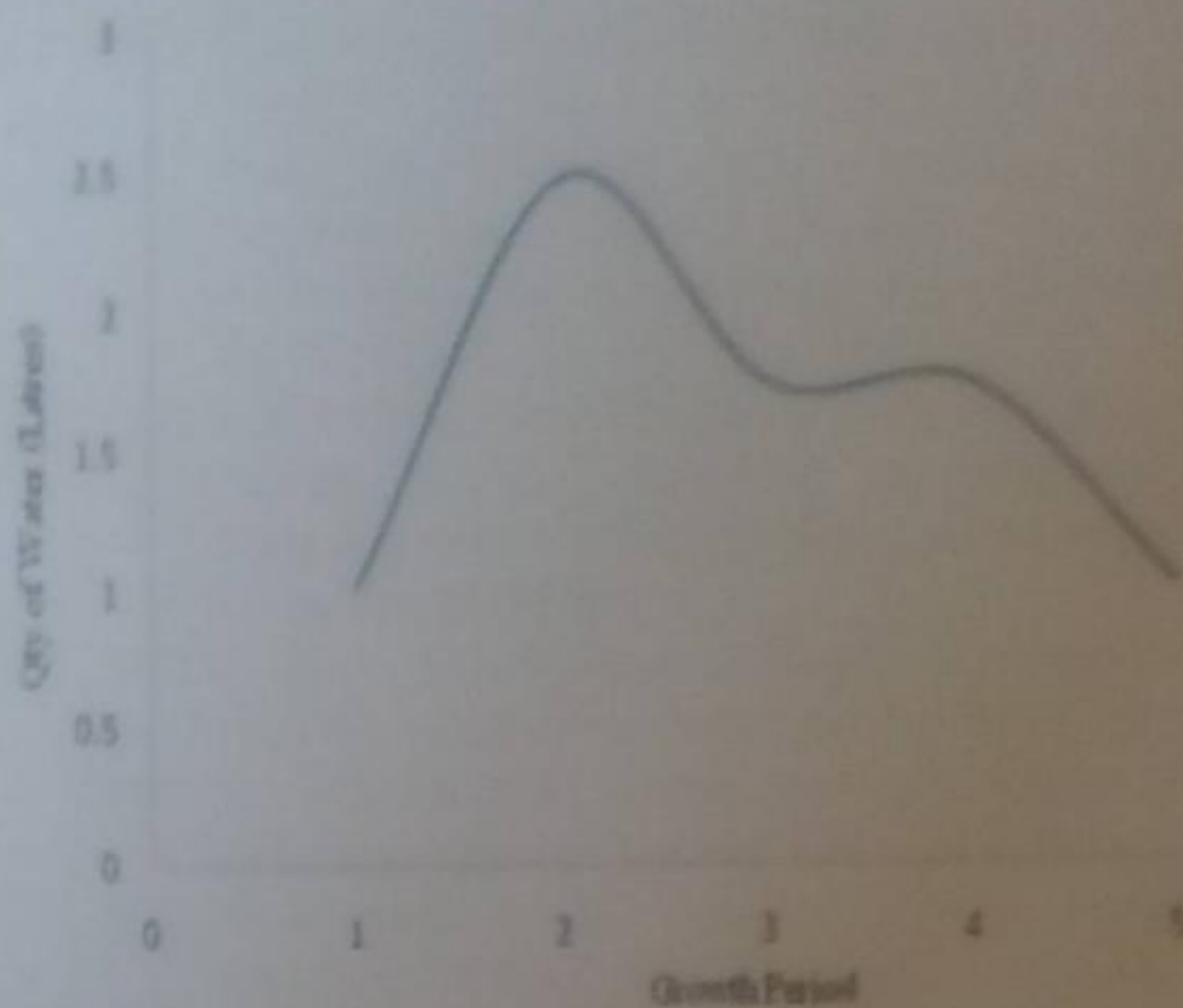

Figure 9: Water Irrigation Curve for Maize

From the nature of the curve in figure 9, it can be seen that the water used up per stand during irrigation by selecting a round each from each growth period in a season goes from a low for period 1 (establishment period) to a high for period 2 (vegetative period), to a moderate for period 3 (flowering period) and period 4 (yield formation period) and back to a low at period 5 (ripening period). This is against other conventional types of irrigation with a constant graph and requiring even application of water or is based on the discretion of the farmer. Such a type waste water, requires manpower and prone to water logging and water percolation.

IV. CONCLUSION

It can be said that the test results were in consonance with intended objectives as the device provide a real time feedback control system which efficiently monitors irrigation activities for maize crop on the field and can also serve as a model for other crops and soil types. The interactive portion of the system is however network dependent, meaning it can only be incorporated in locations with GSM services. In the case of temporal network failure, the ignore option where the no-response to intention to sprinkle initiates the sprinkling process comes to play after thirty minutes. Supervision of the water tank should be done regularly so as not to run out of water for the system. The focuses of further research are:

The improvement of the system to become multi-crop and multi-soil type by upgrading the microcontroller and its software such that a crop of interest and a soil type can be selected and an effective irrigation management system is ran throughout the crop's life cycle.

Development of a robust underground water outlet pipes that will deliver the required quantity of water needed for each growth period directly at a depth closest to the root hairs. This will further save water losses associated with percolation of water from soil top to desired root depth.

V. REFERENCES

- [1] J. C. Rodda, and L. Ubertini, The Basis of Civilization – Water Science? International Association of Hydrological Sciences (International Association of Hydrological Sciences Press, pp 161, 2004.
- [2] L.K. William, I. Suat, J. Simon, C.D. Yonts and L.M. Derrel, Irrigation Management for Corn. Retrieved on 9th March, 2014 from www.ianrpubs.unl.edu/pages/publicationD.jsp?publicationId=1004
- [3] Civil Engineers Forum. Retrieved on 23th November, 2014 from www.civilengineersforum.com/irrigation-advantages-disadvantages/
- [4] J. Needham, Science and Civilization in China: Volume 4, Physics and Physical Technology, Part 2, Mechanical Engineering. Taipei: Caves Books Ltd, pp. 344-346, 1986.
- [5] Water Issue Brief. Wastewater use in agriculture: Not only an issue where water is scarce! International Water Management Institute, 2010.
- [6] S.V. Zonn, Tropical and Subtropical soil science 2nd Edition. Mir publishers, 2 Pervy Rizhsky pereulok I-110, GSP, Moscow, 129820 USSR. pp. 67, 1986.
- [7] F.A.O, Retrieved on 19th March, 2014 from <http://www.fao.org/docrep/w4347e/w4347e0c.htm>
- [8] P. Bandiyopadhyay, Effect of soil moisture levels on root distribution, water uptake and crop coefficient of winter maize in a humid tropic region. Retrieved on 20 April, 2003 from www.academia.edu/Effect_of_soil_moisture_levels_on_root_distribution_water_uptake_and_crop_coefficient_of_winter_maize_in_a_humid-tropical_region
- [9] G.W. Leeper and N.C. Uren, Soil Science: An Introduction, 5th edn. Melbourne University Press, Melbourne. pp. 25, 1993.
- [10] D. Raes, P. Steduto, T.C. Hsiao and E. Fereres, AquaCrop--The FAO Crop Model to Simulate Yield Response to Water: II. Main Algorithms and Software Description. Agronomy Journal. pp. 101, 438-447, 2009.
- [11] P. Steduto, T. Hsiao, D. Raes and E. Fereres, AquaCrop--The FAO Crop Model to Simulate Yield Response to Water: I. Concepts and Underlying Principles. Agronomy Journal. pp. 426-437, 2009.
- [12] www.clemson.edu/extension/hgic/plants/other/irrigation/hgic1804.html.
- [13] O.B. Dennis, Manual for Maize Production. Bunso cocoa college. 2011. Retrieved on 10/3/2015 from www.slideshare.net/DENNIS90/manual-for-maize-production-9558330.
- [14] T. Phil, Growth stage guidelines: Early-season corn irrigation needs. Delta Farm Press. pp. 20-25, 2003.
- [15] B. Grob and E.S. Mitchel, Basic Electronics. (9th ed.). Columbus: Glencoe/McGraw-Hill, pp.1,5, 2003.
- [16] A. G. Ibrahim, O.D. Oyedum, O.B. Awojoyogbe and S.S.N. Okeke, Developmental features and implementation challenges of electronic pest control devices in developing countries. International Journal of Scientific and Engineering Research, 5(2), 411- 416, 2014.
- [17] A.G. Ibrahim, Development and Performance Evaluation of a Solar-Powered Ultrasonic Device for the Control of Weaver Birds in Farms. A Ph.D thesis, Physics department, Federal University of Technology, Minna, Nigeria. pp.103-107, 2015.
- [18] C.A. Shuler, Electronic Principle and Application. Glencoe/McGraw Hill Columbus. pp 7, 1984.
- [19] M. Kretschmar and S. Welsby, Capacitive and Inductive Displacement Sensors in Sensor Technology Handbook, J. Wilson editor, Newnes: Burlington, MA. pp. 77-84, 2005,
- [20] P.M. Levy and Z. Shufeng, Electrical Conductivity of Magnetic Multilayered Structures." Physical Review Letters 65.13 1643-646, 1990.
- [21] At89c52 Datasheet. Retrieved on 3rd May, 2013 from www.alldatasheet.com/At89c52