

DESIGN AND CONSTRUCTION OF AUTOMATIC HEAT ALARM SYSTEM

BY

SALAWU TAWA.O
98/7226EE

DEPARTMENT OF ELECTRICAL COMPUTER ENGINEERING
SCHOOL OF ENGINEERING AND ENGINEERING TECHNOLOGY
FEDERAL UNIVERSITY OF TECHNOLOGY, MINNA
NIGER-STATE

THESIS REPORT SUBMITTED IN PARTIAL FULFILMENT FOR THE AWARD
OF BACHELOR OF ENGINEERING DEGREE (B.ENG)
IN ELECTRICAL/ COMPUTER ENGINEERING

NOVEMBER 2004

DESIGN AND CONSTRUCTION OF HEAT AUTOMATIC ALARM SYSTEM

BY

SALAWU TAWA.O
98/7226EE

DEPARTMENT OF ELECTRICAL COMPUTER ENGINEERING
SCHOOL OF ENGINEERING AND ENGINEERING TECHNOLOGY
FEDERAL UNIVERSITY OF TECHNOLOGY, MINNA
NIGER-STATE

NOVEMBER 2004

DECLARATION

I hereby declare that this project work was wholly and solely conducted by me, under the supervision of Engineer T. Asula, department of Electrical and Computer engineering, Federal University of technology, Minna.

Salau Tawa Opeoluwa



CERTIFICATION

This is to certify that this work titled 'Design and Construction of Automatic Heat Alarm System' was carried out by Salau Tawa O., under the supervision of Engineer T.Asula for the award of Bachelor of Engineering in Electrical and Computer Engineering Department, Federal University of Technology, Minna.

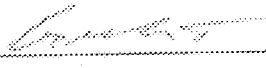

Engineer T. Asula
Supervisor

15. 12. 2004

Date

Engr.M. D. Abdullahi
H.O.D

Date

External Examiner

Date

DEDICATION

This project is dedicated to the Almighty creator for His guidance and protection over me throughout my academic career and also to my parents without whose contribution I might not have had the opportunity of writing this project.

ACKNOWLEDGEMENT

I wish to express my profound gratitude to the Almighty Allah for sparing my life to be able to do this project work and for His strength that sustained me throughout the period of my study in F.U.T. Minna.

I also wish to thank my supervisor, Engineer T. Asula for his assistance, constructive criticism, kindness, patience and understanding, who despite numerous tasks has found much time to supervise every step of this work. Also to my H.O.D., Engineer M.D. Abdullahi, and the entire staff of the Department of Electrical Computer Engineering. I remain ever grateful for your indefatigable effort.

I attributed this success to my parents Mr. and Mrs. Salau whom I owe a lot. I cannot cease thanking you for the rest of my life because you have placed in my hands and etched on my heart what will always keep me above. Also I am grateful to Alhaja B. Olatunde who has seen me through the ups and downs in the turbulent water of my academic career as far as I have gone and my entire life as a whole.

Due acknowledgement to my siblings for their moral support and encouragement, Mr. Kayode Ogunba, Fatimoh, Risi, Kuburat, Bisola, Sola and Taofeek. Also to my mentor, Engineer E. Okoro and Dr. N. Egharevbha

My special appreciation goes to Olayinka Adesola Nasir for his love and contributions in all ways to my achievement. To all my colleagues and friends whom we have shared ideas together, Funsho, Mike, Ajibola, Tayo, Edwin, Roy, Zubbic, Emeka, Seyi, Sulaiman, Salawu, Yejide, Eunice, Bukky, Latifat and Bola Owolabi, I appreciate you all.

ABSTRACT

The report presents the design and construction of an automatic heat alarm system which is a temperature control for a machine.

The aim is to indicate when a machine is over-heated, it triggers on an alarm if it has exceeded a particular temperature and when it is cool it triggers an audio sound to indicate the state of the machine. (I.e. hot or cool).

It features a thermistor (which senses the heat), control unit and audio generation (alarm).

TABLE OF CONTENTS

TITLE PAGE	
DECLARATION	ii
CERTIFICATION	iii
DEDICATION	iv
ACKNOWLEDGEMENT	v
ABSTRACT	vi
TABLE OF CONTENTS	vii
CHAPTER ONE	
1.0 GENERAL INTRODUCTION	1
1.1 DEFINITION OF ALARM	1
1.2 SCOPE OF WORK	2
1.3 MOTIVATION	3
1.4 AIM AND OBJECTIVE	4
CHAPTER TWO	
2.0 LITERATURE REVIEW	5
2.1 HISTORICAL BACKGROUND	5
2.2 TYPES OF ALARM	6
CHAPTER THREE	
3.0 SYSTEM DESIGN	7

3.1	POWER SUPPLY UNIT	7
3.2	HEAT SENSOR UNIT	11
3.3	OSCILLATOR (4060B)	17
3.4	TIMING UNIT	20
3.5	CONTROL UNIT	23
3.6	AUDIO GENERATOR AND HEAT INDICATOR	26

CHAPTER FOUR

4.0	CONSTRUCTION, TESTING AND RESULT	28
4.1	CONSTRUCTION	28
4.2	TESTING AND RESULT	28
4.3	PRECAUTIONS	28

CHAPTER FIVE

5.0	CONCLUSION	29
5.1	RECOMMENDATION	29
	LIST OF COMPONENTS	30
	REFERENCES	31

CHAPTER ONE

1.0 INTRODUCTION

1.1 DEFINITION OF AN ALARM SYSTEM

Systems, which operate a warning device after the occurrence of an abnormal or dangerous condition. Alarm systems are used to signal undesirable or dangerous situation such as the presence of an intruder or the existence of a run away condition in a petroleum refinery process. In factories, this system signals such as excessive process temperature or pressure or rapid change in a process condition.

Alarm systems are usually open loop control system. A basic alarm system contains two essential components: an alarm detector and an alarm indicator. Frequently, they are remote control systems, that is, the detector is located remotely from the indicator.

1.1.1 ALARM DETECTORS

Alarm detectors are used to monitor a given situation and provide the information required to decide whether or not an abnormal or dangerous condition exists. The type of detector is determined by the particular application and by the nature of the physical quantity being detected.

1.1.2 ALARM INDICATORS

Alarm indicators are used to translate the information from alarm detectors into a warning signal when a predetermined limit is exceeded. The warning usually is accomplished by means of a visual or an audible signal. These signals can be as commonplace as the flashing light and ringing bell that are often found at a railroad grade crossing.

1.2 SCOPE OF WORK

An automatic heat alarm system is a device that senses the presence of heat above a certain limit in a system or machine due to operation with a specific temperature grade thermistor.

When the machine is overheated, the device automatically switches off and after appropriate cooling is attained on the machine then the device automatically switches on. It operates in a way that the sensor senses the presence of heat in the system it is connected to and then triggers an alarm, which is through the speaker.

The automatic heat alarm system comprises of discrete components such as thermistor (temperature dependent resistor), speaker, integrated circuits and light emitting diode to indicate light, which are coupled in order to achieve the desired performance.

The use of such reliable components will improve the performance of the system as a whole. The system has found its way in various applications in commercial industry and agricultural fields.

The automatic heat alarm system uses two stepper (4017B) as a timer which detect cool state and hot state. When the system is hot, an alarm is triggered with a specific audio sound and when cool it triggers another sound of audio alarm, so that the operator knows which state the machine is at a particular point in time.

The block diagram of the system is shown below to illustrate the stages involved to enhance easier understanding of the work.

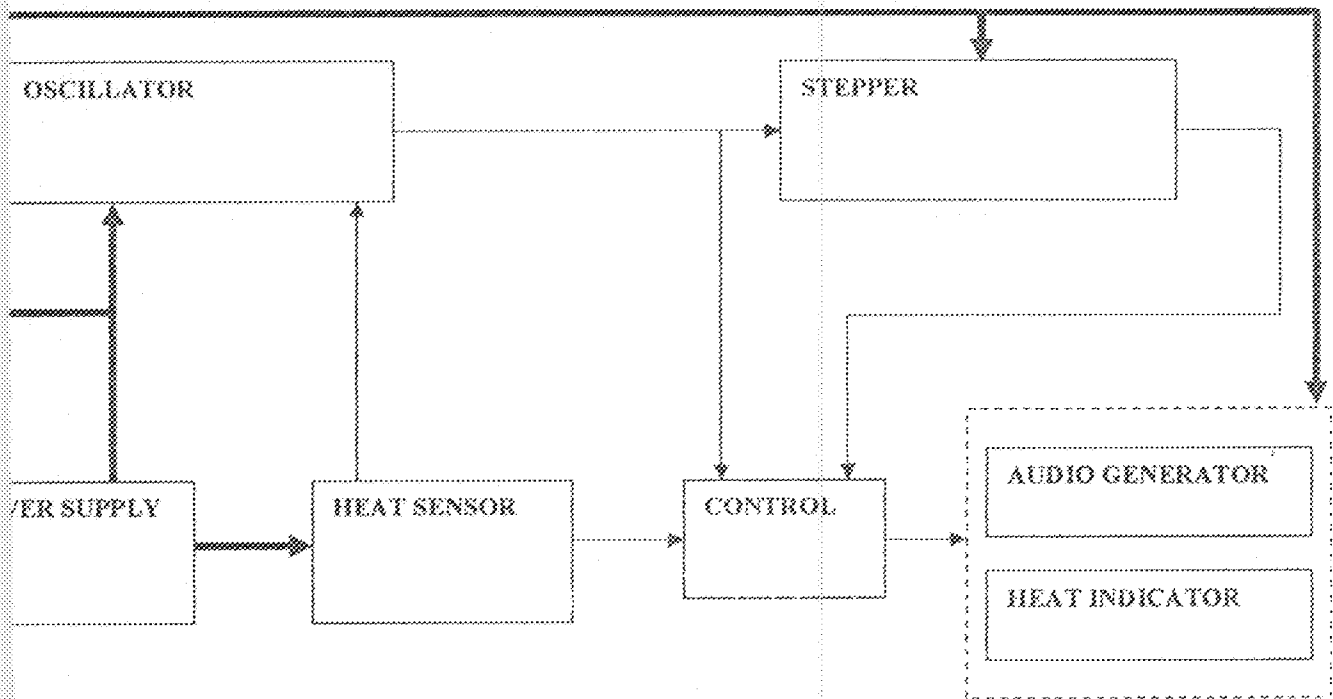

Fig 1.0 Block diagram of automatic heat alarm system

Note

➡ POWER ARROW

→ SIGNAL ARROW

1.3 MOTIVATION

Design of this type of a system is very useful in an industry that uses machine, which must not be overheated, to a certain temperature to avoid damage of the machine. In such machine, a system is placed which triggered an alarm at an over-temperature.

It can also be used in both tertiary and secondary institution (i.e. girls and boys hostel) where the temperature of a room must not be too hot to a certain level in order to avoid casualties among the student such as meningitis, body irritation etc, the system can be placed in a room which triggered on an alarm at an over temperature. This calls the attention of the students to know that the room is no longer conducive for them.

1.4 AIMS AND OBJECTIVES

The aim and objective of this project is to show that the system is a temperature control for an industrial machine and to prevent machines from overheating when in use.

CHAPTER TWO

2.0 LITERATURE REVIEW

2.1 HISTORICAL BACKGROUND

The rate at which fire incidents occur in both electronics and other organisations is serious concern. Fire is always associated with loss of properties, money and in some occasion's loss of life.

Alarm systems are a safety devices designed to alert people of the danger, so that adequate measures could be taken to avert the aforementioned problems. There are many types of an alarm designed for different purposes depending on the need, application, location and cost.

In the industrial sector where safety is the watchword, heat sensing alarm system of this type is a necessity and can be used in the premises.

Heat was a manifestation of energy of motion of the small particles of bodies, according to Galileo a scientist but most of his companions and successors took a different view and imagined that heat was a fluid called caloric that flowed from hot bodies to cold ones/ Modern ideals explain heat and temperature in terms of motion of molecules of a substances. Heat is not a materials fluid but a form of energy, which flowed from one body to another. When heat enters a body, the temperature of the body rises and that makes the body to get hotter. Many instruments have been used to measure heat, examples of which include resistance temperature- detector, thermistor, thermocouple and pyrometer.

2.2 TYPE OF ALARM SYSTEMS

There are various types of alarm designed for different application at different location. They are smoke alarm, fire alarm, clock alarm, process alarm system and so on.

BURGLAR ALARM

In a burglar alarm, a metallic tape is usually placed at all entrances to the building. This tape has an electric current passing through it, which causes an electromechanical relay to be activated. Any intruder entering the building breaks the tape, interrupting the current to the relay contacts to operate the alarm indicator.

PROCESS ALARM

In a petroleum refinery, process alarm systems are used to indicate abnormal or dangerous conditions in many phases of the refinery process. Detector such as thermocouples, temperature detectors (RTDs) or temperature-sensitive switches are used to monitor levels and changes of temperature in different phases of the process. These detectors are used to warn operating personnel when temperature levels are changing too fast or have exceeded safe limits.

CHAPTER THREE

3.0 SYSTEM DESIGN

3.1 POWER SUPPLY UNIT

Power supply is an electrical circuit that supplies the device with electrical energy. It can either be battery or rectified a.c. The term power supply in this context is used to refer to the complete circuitry which perform the conversion from a.c to d.c, including the main transformer which is normally used to isolate the d.c supply form the a.c mains. To convert a.c to required d.c, the circuit diagram below was used.

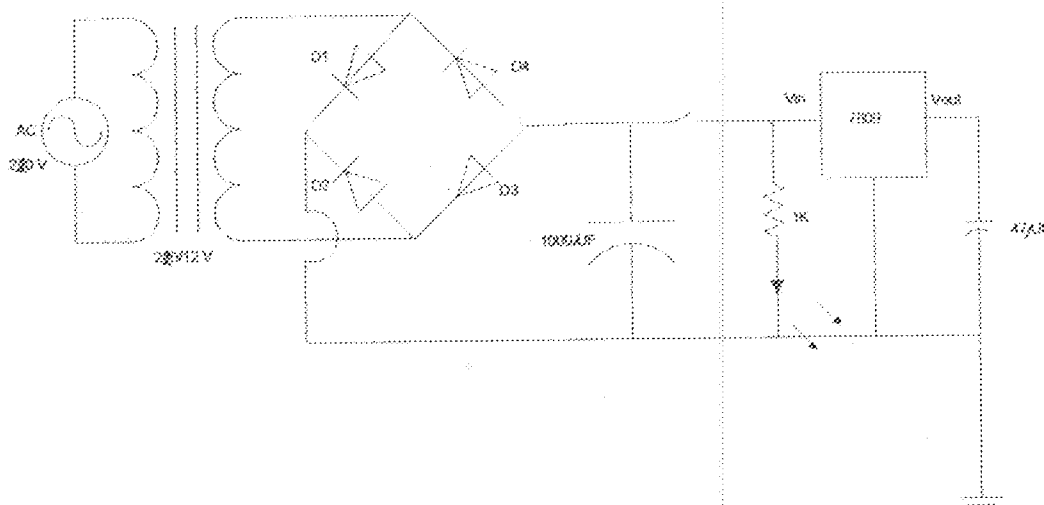

Fig 3.0 Full wave bridge rectifier circuit

The circuit consists of a transformer, full bridge rectifier and a filter capacitor. The input to the circuit is an alternating current supply (a.c), which is stepped down from 220V to the required 12V to be used in the circuit. A 7809 regulator with breakdown voltage of 9V is used to regulate the voltage that goes to the integrated circuit used, as it requires only 9V supply. The capacitor across the output improves transient response and keeps the impedance low at high frequencies.

The transformer, step down the voltage according to the ratio of its turns as shown below.

$$\frac{V1}{V2} = \frac{N2}{N1} = K \text{-----3.1}$$

Where K is a constant known as transformer turns ratio.

Therefore from equation (3.1) the transformer output voltage is given by:

$$V2 = \frac{N1V1}{N2} \text{-----3.2}$$

The voltage will then serve as an output to the rectifier.

The rectifier consists of four diodes as shown in the figure above. During the positive half cycle, diodes D1 and D3 are forward bias and are conducting since their p sides are more positive relative to the n sides. At the same time diodes D2 and D4 are reversed biased since their n sides experienced negative voltage in relative to their p sides.

During the negative half cycle diodes D2 and D4 are forward biased and are conducting since their p sides are more positive relative to their n sides while D1 and D3 are reversed biased since their n sides' experienced negative voltage relative to their p sides. In both cases, current keeps flowing through load resistance R_L in the same direction.

Hence, fluctuating voltage develops across the load thereby; the waveform at figure (a) is formed, which is full wave rectification.

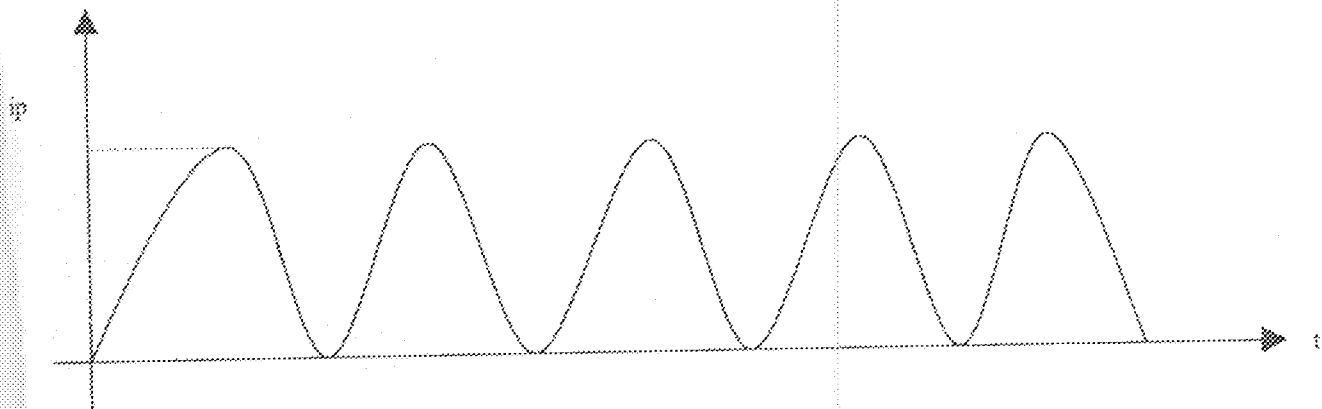

Fig (a) Full- wave rectification

FILTERING

The D.C generated after rectification has ripples, hence, the need for filtering is to smoothen out the pulsation in the output. The output is different from that of full-wave rectifier, as is shown in fig (b).

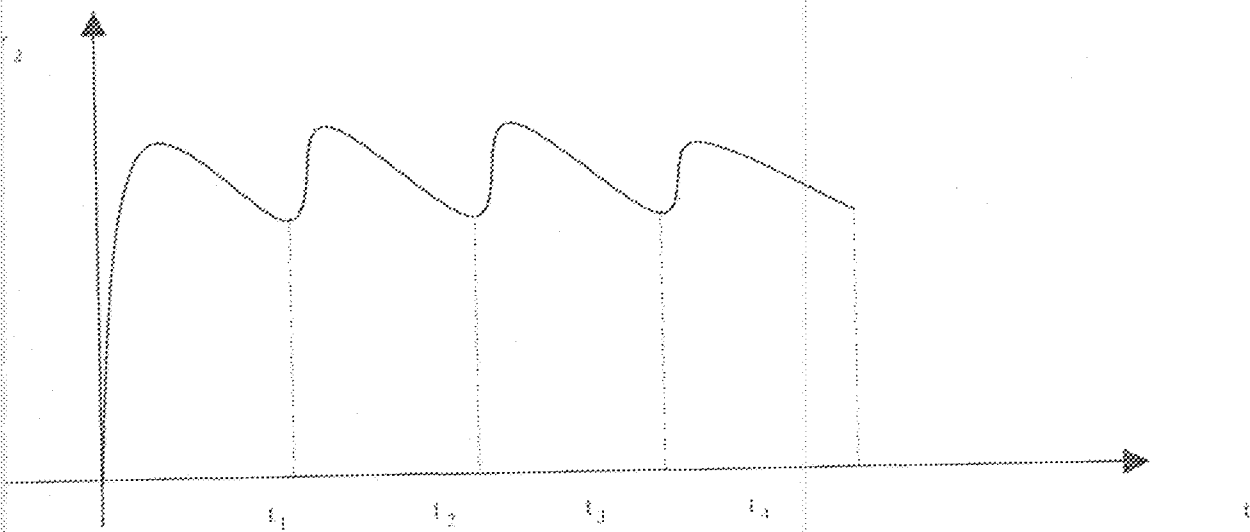

Fig. (b) Output wave form

The diodes D2 and D4 conduct from t_1 and t_3 , thereby charging the capacitor C to the peak value of the voltage across the secondary transformer winding. The voltage at point A of the circuit drops below V_R at t_2 , hence, the diodes are off from t_2 to t_3 , no diode is conducting, current is supplied by capacitor C energy which is being discharged, voltage at B rises to a value enough to turn-on diodes D3 and D4. C is being charged back to its peak value by current pulse.

Calculation at the filtering capacitor:

$$Y = \frac{1}{4\sqrt{3}fR_L C}$$

Making C subject of the formula;

$$C = \frac{1}{4\sqrt{3}fR_L Y}$$

where R_L = Load resistor

Assuming Y to be 0.3%

Y = Ripple factor

Where $f = 50\text{Hz}$

F = Frequency

$$R_L = 1\text{K}\Omega$$

$$C = \frac{1}{4\sqrt{3} \times 50 \times 1000 \times 0.003}$$

$$= 0.96 \times 10^{-3} \approx 1 \times 10^{-3}$$

$$\Rightarrow 1\text{mf} \approx 1000\mu\text{f}$$

$$\text{Peak secondary voltage} = 12\text{V} \times \sqrt{2} = 16.77\text{V}$$

Each silicon diode has a threshold voltage of 0.7V

∴ Peak full wave rectifier voltage at filter input

$$V_{ip} = 16.99 - 2 \times 0.7 = 15.5 \approx 16V$$

However, the ripple is reduced to barest minimum by using a capacitor of $1000\mu f$, 16V which has been found that increasing the capacitor size reduces the magnitude of ripple voltage.

3.2 HEAT SENSOR UNIT

This unit consist of a transistor and a heat sensor device which is used to vary the base voltage V_{be} . Heat sensor device is a device which its characteristics vary as temperature varies. We have various heat sensor devices e.g.

1 Resistance temperature detector

2 Thermocouple

3 Thermistor

4 Pyrometer

5 Fibre sensor

But in this circuit thermistor is used.

3.2.1 THERMISTOR

Is an input transducer (sensor) which converts temperature (heat) to resistance. It is made from a sintered mixture of the oxide of nickel, zinc, copper and manganese. Almost all thermistor have a negative temperature co-efficient (NTC) which means their resistance decreases as their temperature increases. It is possible to make thermistor with a positive

temperature coefficient (resistance increases as temperature increases) but these are rarely used.

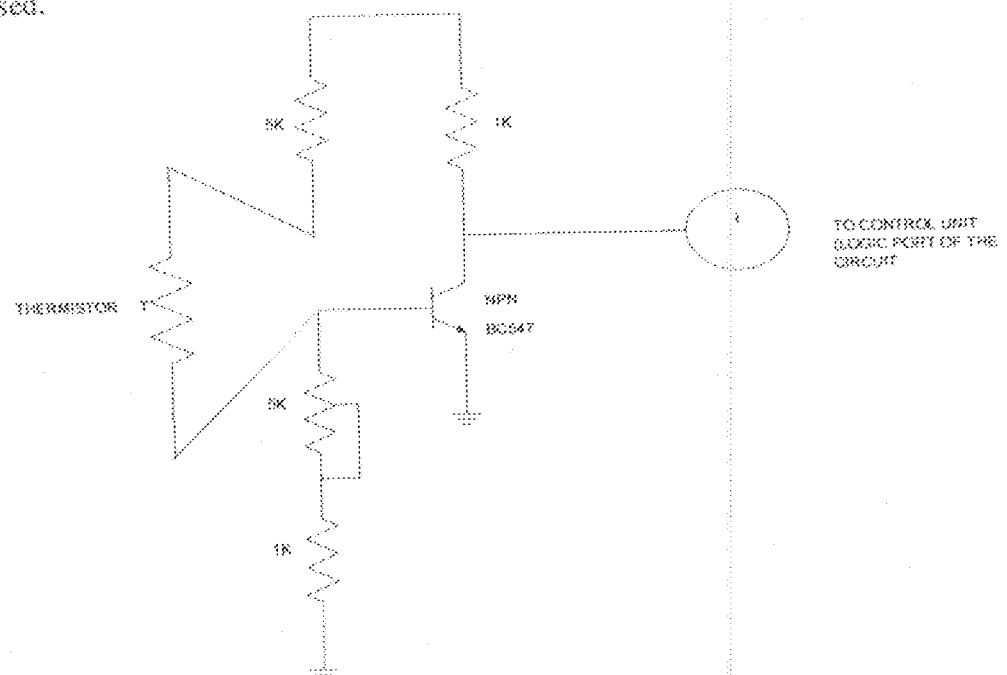

Fig. 3.1 NPN transistor with thermistor connected

The base of the transistor is connected to a load (thermistor). While the emitter side is grounded. Thermistor is a high sensitive material with high resistance. Initially when heat is not applied to the system i.e. when the machine is not heated up, the voltage of the base is at zero volts. As the temperature increases, the resistance of the thermistor decreases. The breakdown voltage for the transistor is typically 0.7V, and as such as the resistance of the thermistor basically begins to conduct i.e. the collector sides of the transistor gets to its saturation point, so it begins to conduct. This now serves as input to the control unit i.e. logic part of the circuit diagram. The thermistor forms part of the resistor used for the switching circuit in the sensor unit.

ANALYSIS

To switch on a CMOS gate with V_{cc} at 9V

$$\text{Input voltage} = \frac{2}{3}V_{cc}$$

$$= \frac{2}{3} \times 9V = 6V$$

The input current for High level = 0.265mA

$$\text{Power (max)} = 1W$$

$$\text{Dissipation factor} = 5.5\text{mW}/^{\circ}\text{C}$$

$$\text{Max operating temperature} = 125^{\circ}\text{C}$$

$$\text{Min operating temperature} = -25^{\circ}\text{C}$$

$$R \text{ at } 25^{\circ}\text{C} = 1500\Omega$$

$$B (^{\circ}\text{K}) = 4100$$

$$R \text{ at } 125^{\circ}\text{C} = 48\Omega$$

Hence the output of a transistor configured as a switch is 6V, 0.3Ma

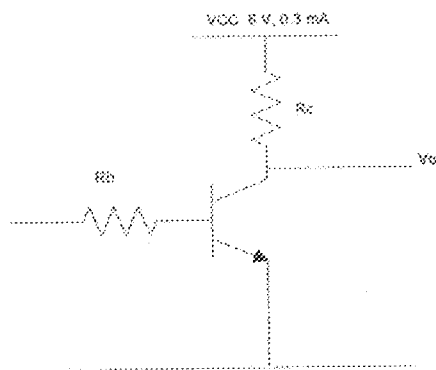

The transistor chosen has the following parameters

$$BV_{CBO} = 60V, BV_{EBO} = 6V, BV_{CEO} = 30V$$

$$I_C = 0.6mA$$

$$h_{fe} = 200$$

$$P_s = 500mW$$

For the above configuration current flowing through R_C

$$I_C = \frac{V_{CC}}{R_C} = 0.3mA$$

$$0.3mA = \frac{9}{R_C}$$

$$\Rightarrow R_C = \frac{9}{0.3mA} = \frac{9 \times 10^3}{0.3} = 30 \times 10^3 = 30K\Omega$$

but $I_b = I_C / \beta$, where $\beta = 200 =$ current gain

$$I_b = \frac{0.3mA}{200} = 0.0015mA$$

$$R_b = \frac{V_b - V_{BE}}{I_b}$$

$$= \frac{V_b - 0.7}{0.0015 \times 10^{-3}}, \quad 0.7 \text{ for silicon semiconductors.}$$

From the configuration given,

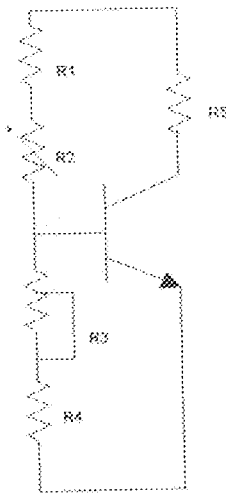

$$R_s = (R_1 + R_2) // (R_3 + R_4)$$

$$\text{Case 1: } R_s = R_1 / (R_3 + R_4)$$

i.e. thermistor resistance is zero (max temp.)

but max temp. is 125°C and $R = 48\ \Omega$

$$\text{hence } R_s = (5\text{K} + 48) // (5\text{K} + 1\text{K})$$

$$= \frac{5048 \times 6000}{5048 + 6000} = \frac{30288000}{11048} = 2741.4917 \approx 2.74\text{K}\Omega$$

At minimum temp. -25°C and $R = 1500\ \Omega$

$$R_s = (1500 + 5000) // (5000 + 1000)$$

$$= 6500 // 6000$$

$$= \frac{6500 \times 6000}{6500 + 6000} = \frac{39000000}{12500} = 3120 \approx 3.12\text{K}\Omega$$

where $R_s = 2.74\text{K}\Omega$

$$I_s = \frac{V_s - V_{BE}}{R_s}$$

$$V_b = I_b R_{th} + V_{be}$$

$$= 0.0015 \times 10^{-3} \times 2.74 \times 10^3 + 0.7$$

$$= 0.70411V$$

when $R_3 = 3.12k\Omega$

$$V_b = I_b R_b + V_{be}$$

$$= 0.0015 \times 10^{-3} \times 3.12 \times 10^3 + 0.7$$

$$= 5.38V$$

The range of $V_b = 0.7$ to $5.38V$

For the transistor to switch on;

$$V_b > 0.7$$

At minimum temperature the transistor is

$$R_3 = 5k\Omega$$

when $R_3 = 0$ at minimum temperature

$$R_{th} = R_1 + R_2 // R_3$$

$$= (5000 + 48) // 1000$$

$$= \frac{5048 \times 1000}{5048 + 1000} = 834.7\Omega \approx 0.8347k\Omega$$

$$V_b = I_b R_b + V_{be}$$

$$= 0.0015 \times 10^{-3} \times 834.7 + 0.7$$

$$= 0.701252V$$

$$R_1 = 1500\Omega$$

$$\begin{aligned}
 R_b &= (5000 + 1500) // 1000 \\
 &= 6500 // 1000 \\
 &= \frac{6500 \times 1000}{6500 + 1000} = 0.8667 K\Omega
 \end{aligned}$$

$$\begin{aligned}
 V_b &= I_b R_b + V_{BE} \\
 &= 0.8667 K \times 0.0015 \times 10^{-3} + 0.7 \\
 &= 0.7013 V
 \end{aligned}$$

3.3 OSCILLATOR

An oscillator is an electronic circuit designed to provide an alternating e.m.f of known frequency and waveform.

4060B is a CMOS oscillator, which produces ten different frequencies from a main frequency input or oscillator. It has 14 J.K flip-flops, which divide the main frequency into 14 others. But only ten are fed out of the I.C. The oscillator configuration allows design of either RC or crystal oscillator circuits. Also included on the chip is a reset function which places all outputs into the zero state and disables the oscillator. A negative transition on clock will advance the counter to the next state. Though we have ten frequencies from a main frequency input but only three frequencies is being used in this project, namely h_1 , h_2 , h_3 and h_4 .

h_1 - is for cool detection

h_2 - is for heat detection

h_3 and h_4 - is a modulating pulse from the oscillator for alarm effect.

The pin assignment of 4060B is shown below

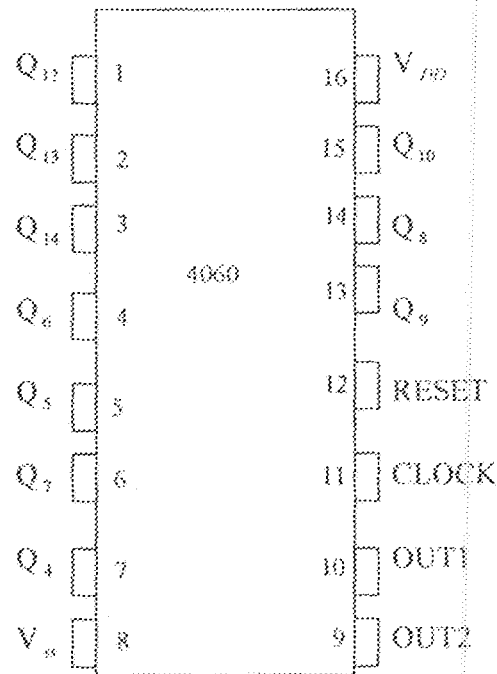

Fig 3.2 PIN ASSIGNMENT

Shown below is oscillator circuit using RC configuration

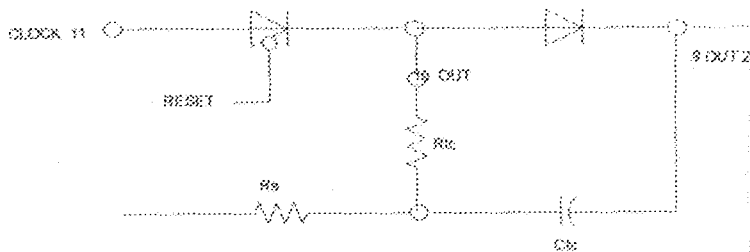

Fig. 3.3 Oscillator circuit using RC configuration

The frequencies are calculated as follows and out of the 14 frequencies only 4 is selected for different functions

$$F = \frac{1}{2.3R_u C_u}$$

Where $R_u = 33k\Omega$

$$C_u = 0.01\mu F$$

$$\therefore F = \frac{1}{2.3 \times 33 \times 10^3 \times 0.01 \times 10^{-6}}$$

$$= 1317.5230571 \text{ Hz}$$

Q1	658.76
Q2	329.38
Q3	164.69
Q4	82.35
Q5	41.17
Q6	20.59
Q7	10.29
Q8	5.15
Q9	2.57
Q10	1.28
Q11	0.64
Q12	0.32
Q13	0.16
Q14	0.08

3.4 TIMING UNIT

This unit consist of two 4017B, which is Decade counter (1-of-10). Namely :

(4017B)1, which is a timer for cool state detector and (4017B)2, which is a timer for hot state detector

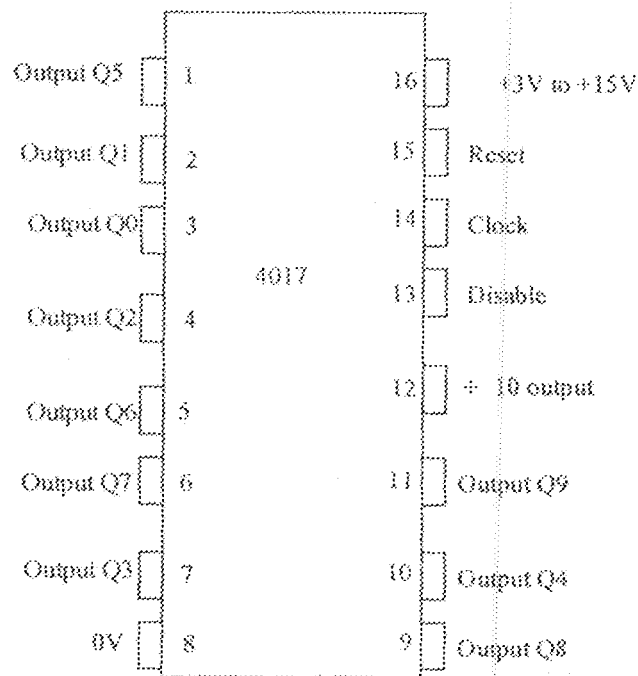

Fig 3.4 Pin Assignment

The count advances as the clock input becomes high (on the rising edge). Each output Q0-Q9 goes high in turn as counting advances.

The reset input should be low (0V) for normal operation (counting 0-9). When high it resets the count to Zero (Q0 high). This can be done manually with a switch between reset and +vs. and a 10k resistor between reset and 0V. Counting to less than 10 is

achieved by connecting the relevant output (Q0-Q9) to reset, for example to count 0,1,2,3 connect Q4 to reset. The disable input should be low (OV) for normal operation. When high it disables counting so that clock pulses are ignored and the count is kept constant. However, the two timers (4017B) are clocked by the output of oscillator (4060B). The reset pins of 4017B are connected in the following ways:

- i) [4017B] 1 is connected directly to the output of the heat sensor unit.
- ii) [4017B] 2 is connected to the inverted output of the heat sensor unit.

This implies that only one of the two 4017B IC would be counting at a point in time.

The operation of this unit is to stop the alarm after about two minutes. Thereby it follows these conditions.

When hot, the output of the sensor is at low state; this will then reset the (4017B) 1 IC.

At this periods the (4017B) 2 will start counting. Also, when cold, the output of the sensor unit is at high state, which will reset the (4017B) 2 and (4017B) 1 will also start counting. Either of the two 4017B IC could be disabled by the output signal at pin 11, this implies that after the count of 9 by the counter which is almost equivalent to 2minutes this will definitely stop the alarm.

3.5 CONTROL UNIT

The control section consist of three inverter (1,2 and 3), three OR gate (1,2 and 3) and four AND gate (1,2, 3 and 4).

This section talked about the logic part of the circuit and how it's controlling audio section.

3.5.1 AND GATE

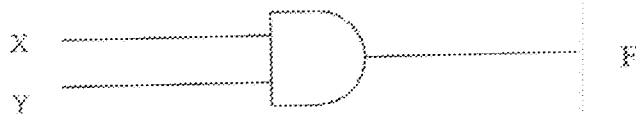

If any variable is ANDed with 0, the result must be 0. This is easy to remember because the AND operation is just like ordinary multiplication, where we know that anything multiplied by 0 is 0. We also know that the output of an AND gate will be 0, whenever any input is 0, regardless of the level of the other input. This can be illustrated with the truth table below.

X	Y	F
0	0	0
0	1	0
1	0	0
1	1	1

3.5.2 OR GATE

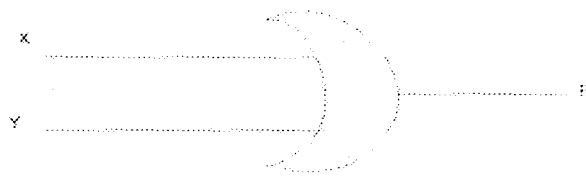

If any variable is ORed with 1, the result will always be 1, we check this for both values X and Y. Equivalently, we can remember that an OR GATE output will be 1 when any input is 1, regardless of the value of the other input as shown below

X	Y	F
0	0	0
0	1	1
1	0	1
1	1	1

3.5.3 INVERTER

The device invert signals from high to low, low to high depending on the signal coming in as input

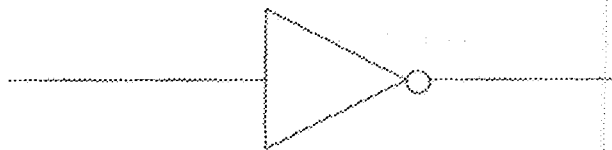

However, the output from heat sensor unit can be high or low. When the machine is hot the output is high, then it goes to inverter 1 as input i and comes out as low k , so also when the machine is cool the output is low and it goes to inverter 1 as input and comes out as high.

That is:

When the machine is hot

i is logic 1

k is logic 0

When the machine is cool

i is logic 0

k is logic 1.

When i is high 1 (hot) it is connected to AND gate 4 and enabled it by passing h_2 , then k is logic 0 which is connected to AND gate 2 and disable it. The output of AND gate 2 and h_4 is summed up in OR gate 3 which gives an output $(0+h_4)$ which serves as one of the input to OR gate 2 and the other input is the output of AND gate 4 (h_2) which is summed up to give mixed frequency (h_2+h_4) . Timer B (4017B 2) is enabled causing a timed-gap to access a particular audio frequency quite different from cool alarm. Pin 11 of both Timer A (4017B 1) and Timer B (4017B 2) is summed up in OR gate 1 and inverted to disable h_3 in AND gate 1. Then the mixed signal which comes out of AND gate 3 is fed to the N channel mosfet. And comes out as an amplified audio signal from the speaker. Similarly, when i is logic 0, it is connected to AND gate 4 and disable it. k is logic 1 which is connected to AND gate 2 and enable it, thereby passing h_3 . The output of AND gate 2 and 4 is summed up in OR gate 2. i is logic 0 which enable timer A (4017B 1)

causing OR gate 1 output to have logic 0 for a particular time. The logic 0 is inverted by an inverter and available at one if the inputs of AND gate 1. h_1 at the other input is passed through to the output of the AND gate 1. The output of OR gate 2 and AND gate 1 serve as input to AND gate 3 and gives mixed signal $(h_1 \times h_2)$ as output, the output comes out through the $1k\Omega$ current limiting resistor connected to the gate of the N-channel mosfet and also amplified the speaker. Though the alarm sound of when the machine is hot and cool is different from each other.

3.6 AUDIO GENERATOR/ HEAT INDICATOR

This unit is the output section of the system where an alarm triggers and a sound is heard through a speaker with the aid of an IRF44 mosfet transistor which amplifies the sound and makes it clearer and louder. Two different audio sound is produced in this unit, one for cool state and hot state.

When i output from heat sensor unit is high, is connected to the base of Q2 through a $120k\Omega$ resistor that power the heat indicator ON through a current limiting resistor $1k\Omega$ so that when cool the indicator is merely OFF.

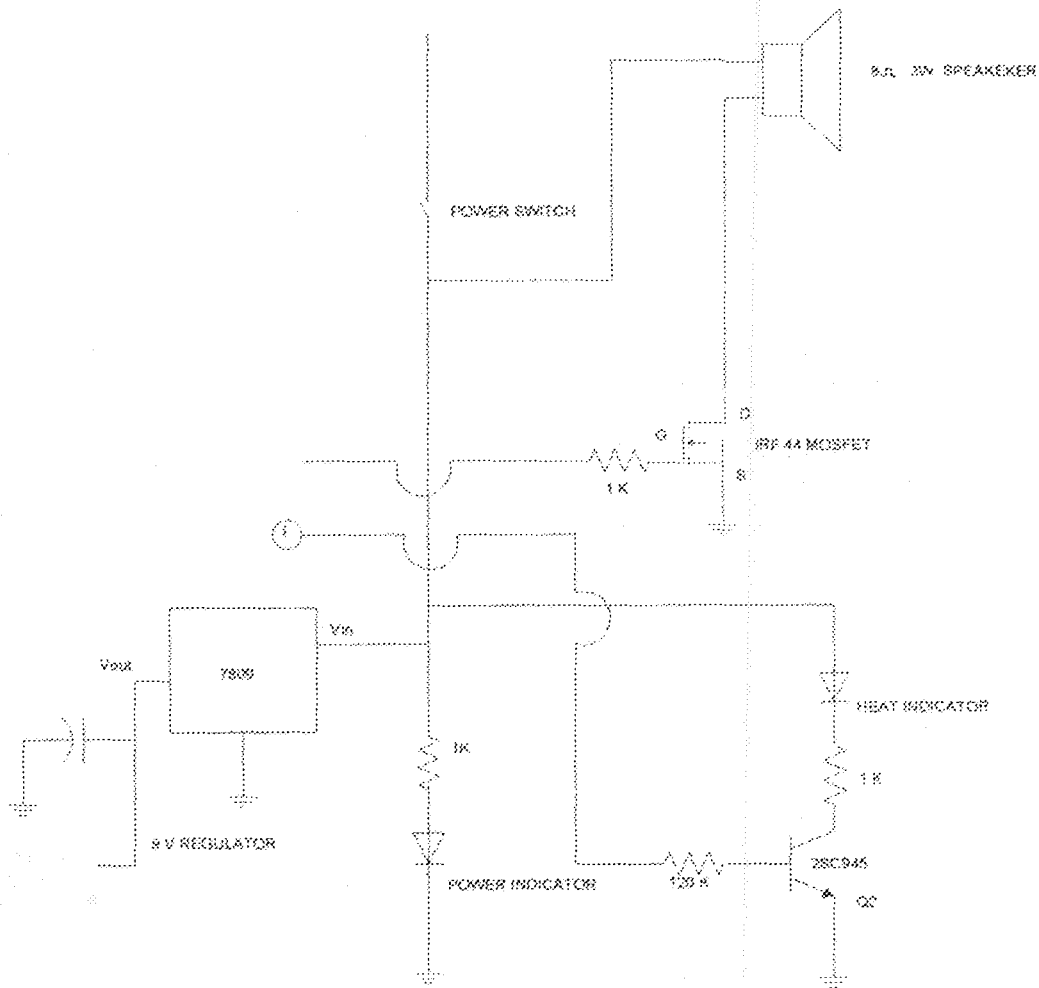

Fig. 3.6 Audio Generator and Heat Indicator Circuit

CHAPTER FOUR

4.0 CONSTRUCTION, TESTING AND RESULT

4.1 CONSTRUCTION

In the construction of automatic heat alarm system, the design specification of each component was strictly adhered to, except in the case of non-availability of the particular components. In such instance, slight adjustment in design specification was unavoidable. The construction includes a prototype on the temporary location of breadboard and then proper construction at the completion of design on the Vero board.

4.2 TESTING AND RESULT

After the system design and construction was completed, testing was carried out to observe the performance of the system/circuit. Adjustment, correction and amendment were carried out where necessary before the final coupling of the system.

4.3 PRECAUTIONS TAKEN DURING CONSTRUCTION

The following precautions were taken during the construction stage,

1. The construction was first carried out on a breadboard and tested before it was finally constructed on the Vero board.
2. Soldering was carefully done to avoid bridge of components.
3. A thorough checking was done to make sure the components are properly mounted in their rightful position.
4. During mounting and dismantling the power supply unit was switched off.
5. Solder splashes were carefully removed to avoid short-circuiting.

CHAPTER FIVE

5.0 CONCLUSION

The design and construction of an automatic heat alarm system may sound and seem to many people an easy task. However, that was not the case. The notion that availability of components and technology advancement would ease the execution was not really so as discovered at the commencement of the project. Thus, identification of components, which could be used as replacements, caused some sort of delay and modifications.

Thus, with a reasonable degree of economy and efficiency, the aim outlined in chapter one have been achieved. The automatic heat alarm system has been designed, constructed and tested to alert people when the temperature increased to a certain limit, then it triggered on an alarm.

5.1 RECOMMENDATION

It will be strongly recommended that any student who will carry out a further work on this project should incorporate a display unit, that will indicate when the system is hot and cool at a particular temperature.

Finally, due to financial constraints, students are normally limited on projects to work on. It is recommended that some private sector and other interesting parties take active parts in sponsoring projects like this.

LIST OF COMPONENTS USED

S/NO	DESCRIPTION	QUANTITY
1	Diode IN4001	4
2	Resistor (100k	1
3	Resistor (33k	1
4	Resistor (5k	1
5	Resistor (1k	1
6	Resistor (2.2k	1
7	Capacitor (0.01	1
8	Capacitor (47	1
9	Capacitor (1000	1
10	Transistor NPN(25C945)	1
11	IC 4081B	1
12	IC 4071B	2
13	IC 7809	1
14	Rectifier IN4002	1
15	Power Indicator	1
16	L.E.D Indicator	1
17	MOSFET IRF44	1
18	Speaker (3W8	1
19	Transformer (220/12v)step down	1

REFERENCES

- a) M.C GAW-HILL, ENCYCLOPEDIA OF SCIENCE AND TECHNOLOGY (5th Edition). Cambridge University Press, 1985, ISBN 042507843 2,253PP.
- b) PAUL HORWITZ & WINFIELD HILL, THE ART OF ELECTRONICS (2nd Edition) (Cambridge University Press) 1989, ISBN: 0521498465, 11225PP.
- c) D.G. FINK, ELECTRONICS ENGINEERS' HANDBOOK.
- d) JERRY C. WINTAKER, THE ELECTRONIC HANDBOOK
Published in co-operation with IEE press, published by CRC press Beaverton-Oregon, (1996) ISBN 061250459.
- e) THERAJA B.L AND THERAJA A.K (1999, Electrical technology S.CHAND and company Ltd, New Delhi, India.
- f) ELECTRONICS SYSTEM & COMPONENTS WITH DENNIS (BUTTER WORTH SCIENTIFIC).

