

IEEE NIGERCON 2017



IEEE 3RD INTERNATIONAL CONFERENCE ON ELECTRO-TECHNOLOGY
FEDERAL UNIVERSITY OF TECHNOLOGY,
OWERRI, NIGERIA

7 - 10TH NOVEMBER, 2017

Proceedings

Proceedings of the
**2017 IEEE 3rd International
Conference on
Electro-Technology for National
Development
(NIGERCON)**

November 7-10TH, 2017.

Federal University of Technology, Owerri, (FUTO), Imo
State, Nigeria.

IEEE Catalog Number: CFP17NIG-ART

ISBN: 978-1-5090-6422-9

Online ISSN: 2377-2697

Print ISSN: 2377-2689

<http://ieeenigercon.org>



Editors

K. C. Okafor

E.E Atimati

I.E. Achumba

Copyright and Reprint Permission:

Abstracting is permitted with credit to the source. Libraries are permitted to photocopy beyond the limit of U.S. copyright law for private use of patrons those articles in this volume that carry a code at the bottom of the first page, provided the per-copy fee indicated in the code is paid through Copyright Clearance Center, 222 Rosewood Drive, Danvers, MA 01923. For reprint or republication permission, email to IEEE Copyrights Manager at pubs-permissions@ieee.org. All rights reserved. Copyright ©2017 by IEEE.

ISBN 978-1-5090-6422-9

Online ISSN 2377-2697

Print ISSN 2377-2689

Table of Content

A Performance Analysis of Logistic Regression and Support Vector Machine Classifiers for Spoof Fingerprint Detection	1-5
<i>Yusuf Ibrahim, Muhammed. B. Mu'azu, Adewale. E. Adedokun, Yusuf. A. SHA'ABAN</i>	
Biometric Face Recognition: Limiting Factors, Merits and Potentials	6-9
<i>J.I Eke and Diala S.O.</i>	
Challenges and Prospects of Blind Spread Spectrum Medical Image Watermarking	10-18
<i>Eze Peter U., Udaya Parampalli, Iwuchukwu Uchechi C., Onuekwusi Nnaemeka</i>	
A Modified Select and Test (ST) Algorithm for Medical Diagnoses in an Ad-Hoc Network	19-23
<i>A. A. Obinyi, O. N. Oyelade, S. B. Junaidu</i>	
Medical Diagnosis Expert Systems for Managing Malaria and Related Diseases for Developing Countries	24-29
<i>K.I. Nkuma-Udah, G.A. Chukwudebe and Ekwumune .E</i>	
Cloud Based Virtual Private Networks Using IP Tunneling for Remote Site Interfaces	30-41
<i>M. N. Ogbu; G.N. Onob ; K.C. Okafor,</i>	
Effects of Slot Dimensions and Operating Frequencies on the Equivalent Magnetic Current Distributions in Slot Antennas	42-49
<i>K. A. Amusa and S. A. Adekola</i>	
Impact of ground plane size on fields radiated by slot antennas	50-56
<i>K. A. Amusa and S. A. Adekola</i>	
Characteristics of Yagi-Uda Array of Linear Elements suitable for Television broadcasting	57-64
<i>A. A. Raji and S. A. Adekola</i>	
Analysis of Broadside and End-Fire Linear arrays of Slot Antennas	65-75
<i>K. A. Amusa and S. A. Adekola</i>	
On The Electromagnetic Characteristics of Dipole Antennas at MF/HF/VHF/UHF	76-85
<i>S. A. Adekola and V. O. Adewuyi</i>	
Linear Array of Physically Resonant Half-Wave Dipoles	86-95
<i>Tolulope C. Erinsho and S.A. Adekola</i>	
Real Time Determination of an Information Content of an Audio Signal a Multidomain Approach	96-100
<i>J. Olawore</i>	
Relay Node Selection for Cooperative Wireless Systems using the Bidder's Game	101-106
<i>Oluseye A. Adeleke, and Damilare O. Akande</i>	
Autoregressive Modeling of Mobile Radio Channel in LTE Network, A Case Study of Ibadan City, Nigeria	107-112
<i>Akande Akinyinka Olukunle, Agubor Cosmas Kemdirim, Ahmed Wasiu Akande</i>	
The Effects of Radiation Emitted from Base Stations and Mobile Phones on Human Beings	113-116
<i>Osabemwen, O.A. , Omorogiuwa, O.</i>	
A Review on Energy and Location Aware Routing Protocols in MANET	117-122
<i>Agbon E. Ezekiel, Aliyu D. Usman, S.M. Sani</i>	
An Examination of Different Selection Approaches for Genetic Algorithm Implementation Process	123-126
<i>H. Bello-Salau, A. M. Aibinu, E. N. Onwuka, J. J. Dukiya and A. J. Onumanyi</i>	
Application of Hybrid Non-Dominated Sorting Genetic Algorithm-II and Self-Organizing Map Technique to Interference Management in Homogenous Frequency Demand Cellular Network	127-133

<i>Adanma Cecilia Eberendu, Benjamin Ohepo Omaiye, Euphemia Chioma Nwokorie</i>	
Implementation of 4X4 Butler Matrix using Silver-nono Instant Inkjet Printing Technology	514-518
<i>Suleiman Aliyu Babale, Sharul Kamal Abdul Rabim, Sani Halliru Lawan, Stella Ifeoma Orakwue</i>	
Structural Analysis of Ball-on-Sphere System Using Bond Graph Technique	519-524
<i>Aliyu D. Usman, Abdulmumin M. Yusuf, Abubakar Umar, Aliu Daniel</i>	
Design of a Hybrid Cloud using Stack Ops Distribution Community Edition	525-531
<i>Iwuchukwu, U.C., Opara, F.K., Atimati, E.E., Ezeb, G.N., Agubor, C.K.</i>	
Quality of Service Evaluation in On-Demand Cloud-Based Video Surveillance	532-537
<i>Nwokolo C.P., Inyama H.C</i>	
Overview of Enterprise Architecture Frameworks and the Effects of Some Modelling Tools on their Usefulness	538- 543
<i>Bilkisu Jimada Ojuolape, Tabir Aduragba, Ayodeji Akeem Ajani, Abdulkadir Adekunle Ahmed</i>	
A New Approach for Improving Decryption of RSA Cryptosystem Based On CRT	544-547
<i>Sabeed Y.K., Gbolagade, K.A.</i>	
An Improved Topology Model for Two-Vehicle Look-ahead and Rear-Vehicle Convoy Control	548-553
<i>Mu'azu J. Musa, Shabdan Sudin, Zaharuddin Mohamed, Yusuf A. Sha'aban, Aliyu D. Usman, Aveen U. Hassan</i>	
Trajectory Tracking Control of Ball On Plate System Using Weighted Artificial Fish Swarm Algorithm Based PID	554-561
<i>Hussein S. U., Muhammed B. M, Sikiru T. H., Umoh I. J., Salawudeen A. T.</i>	
Emulating the distributed detection Approach in Flocks of Birds for SCADA systems	562-569
<i>Michael Okeke, Andrew Blyth</i>	
An Ultrasonic Sensor Distance Induced Automatic Braking Automobile Collision Avoidance System	570-576
<i>Ahmed Aliyu, Jonathan G. Kolo, Olaniyi O. Mikail, James Agajo, Buhari Umar, Okechukwu I. Aguagba</i>	
Human Detection Using Speeded-Up Robust Features and Support Vector Machine from Aerial Images	577-586
<i>Buhari U. Umar, James Agajo, Ahmed Aliyu, Jonathan G. Kolo, Olayemi M. Olaniyi, Samuel O. Owolabi</i>	
Performance of One-level Recursion Parallel Strassen's Algorithm on Dual core Processor	587-591
<i>Ahmad Jibir Kawa, Saminu I, Bala, Yahaya Aishatu Umar</i>	
Improving The Efficiency of Cassava Processing Through An Automated Processing Line	592-600
<i>Joy Nnenna Eneh, Aka Benneth Emeka, Harris Onyeka Orab</i>	
Leave Management Solution for Improved Service Delivery in Nigeria University System	601-612
<i>Bliss Utibe-Abasi Stephen, Gloria A. Chukwudebe</i>	
Design of Active Noise Control for Noise with Pollution Level Detector	613-619
<i>Nwachukwu Nwokefor Kenneth, Igbajar Abraham</i>	
Internet Security and the Future of Internet – a Case for Construction of a New Model	620-629
<i>Agwab Benjamin C., Aririguzo Marvis I., Nwachi-Ikpor Juliana O.</i>	
A Movement Disorder Recognition and Analysis Framework using Non-Contact and Wearable Sensors	630-633
<i>Abiodun E. Onile, and Olugbenga K. Ogidan</i>	
Monitoring of the Aged and Visually Impaired for Ambulation and Activities of Daily Living	634-638
<i>Nwakamma M. N, Achumba I. E, Nwakanma I. G, Ossai R. U. Mbaonu. W. E.</i>	
A Cloud Computing Framework for Delivering Computer Science and Mathematics Instructional Content to Learners	639-643

An Ultrasonic Sensor Distance Induced Automatic Braking Automobile Collision Avoidance System

Ahmed Aliyu, Jonathan G. Kolo, Olaniyi O. Mikail, James Agajo, Buhari Umar, Okechukwu I. Aguagba
Dept. of Computer Engineering Federal University of Technology
Minna, Nigeria

aliyu.ahmed@futminna.edu.ng, jgkolo@futminna.edu.ng, mikail.olaniyi@futminna.edu.ng, james.agajo@futminna.edu.ng,
buhariumar@futminna.edu.ng, jamesokey@gmail.com

Abstract— Collisions in automobiles have become a major safety concern; cases of damage and death due to automobile collisions are frequently reported. The number of pedestrians knocked to death by automobiles is also on the rise in cities and highways. Further into the game reserves, wild animals are also frequently knocked to death by automobiles. The cost of a life cannot be estimated, the cost of damages to the automobiles also impacts negatively on investment. In most cases drivers fail to notice the presence of obstacles ahead and brakes need a driver's response to operate thus increasing the response time, hence reducing their reliability. Many approaches to automobile crash avoidance systems have been proposed in recent time, however, such approaches mainly concentrate on steering maneuvering control. In addition, these approaches do not take into consideration the safety distance to stoppage of the automobile, more so, many approaches only provide a warning signal to the driver for activating the automatic braking. This always provides a room for human error. This paper presents the development of an automatic microcontroller based crash avoidance system that employs obstacle detection and distance measurement using ultrasonic sensors to detect obstacles and their distances. Once the obstacle has been detected and safe separation distance is reached, the automobile performs safety distance induced braking at that distance to bring the automobile to a stoppage. From the results obtained after tests, the system has an average response time of 0.86s to the activation of the brakes and a 12.8 percentage error with respect to the obstacle real distance.

Keywords—Ultrasonic, Collision, Sensor, braking system, Automobile

I. INTRODUCTION

The problem of vehicle accident is a part of an endless list of disaster that could occur anywhere anytime. About 1.2 million people die on the world's roads annually, making it a leading cause of death globally [1]. Low and middle income countries are where most of these deaths occur. Rapid economic growth has increased motorization and road traffic injuries. There are very few road safety measures in developing countries, thus leading to more road disasters. This poses a major challenge as developing countries lose approximately 3% of gross development profit as an outcome of road crashes [2]. Road traffic accident is a leading cause of death for many years, most accident are both preventable and predictable. There are many proofs on ways to help achieve safety on the roads. Some countries that have successfully implemented these solutions have experienced appreciable reductions in road accident deaths. Adopting this mediation globally suggests the

huge potential to avoid future harm and save lives at a universal level [3]. This system is recommended where common faults by drivers are eradicated, with many of the intelligent vehicles have monitoring systems only, such as speed sensors, anti-lock brakes, and other automatic systems present, especially in luxury cars [4, 5], but these cars are not cheap to everyone and thus, a cost effective but efficient system is required for the safety of every car user.

Collision avoidance system is a system made of sensors placed inside a car to caution its driver of any obstruction that could possibly lie ahead on the road [6]. Some of the dangers detected by these sensors include the proximity of the car to other cars around it, and its exact distance from the cars. The ultrasonic sensor is modified to measure the proximity with reference to the previous car for the rear end. Most obtainable ultrasonic sensors for vehicles are approved for approaching cars with comparatively low speed. Whereas the rough reading of proximity data cannot be applied directly, an intelligent method is projected to process the distance read out of sensors to yield suitable cautioning signals and counter measures [7].

Approaches to automobile crash avoidance systems have been based on controlling the steering maneuvering system and on car warning systems that interferes with the vehicle drivers to activate braking systems. Many of those systems are very costly and make it very expensive for middle income earners to own such vehicles. In addition, these approaches do not take into consideration the safety distance to stoppage of the automobile. This always provides a room for human error [8]. Thus, this paper presents the development of an automatic micro controller based crash avoidance system that employ obstacle detection and distance measurement using ultrasonic sensors to detect obstacles and their distances for automatic safety braking of the car without the driver's consent and within the safest distance between the vehicle and the obstacle.

The rest of this paper is structured as follows: Previous related work is presented in section 2, while, section 3 presents the design and implementation of the system. Results obtained from simulation and testing are discussed in section 4 and conclusion drawn from the study is lastly presented in section 5.

II. PREVIOUS RELATED WORK

The collision avoidance system is an automobile safety system designed to reduce imminent and the possibility of an accident. These systems have evolved over time from the dumb systems to current intelligent systems in operation and under research. They use electronic circuitry coupled with distance sensors and sometimes camera sensors to detect an imminent crash. Once the detection is done, these systems either provide a warning to the driver when there is an imminent collision or take action autonomously without any driver input by automatic application of brake [9].

In [10], the approach uses two range sensors, one for forward and another for the reverse end. It detected obstacles when a minimum distance separation is reached. The system is however limited to detection of obstacles and giving warning signals, no countermeasures are however automatically engaged to avoid collision.

Also, [9] presented approach of collision avoidance using laser beams. Firstly, the system estimates the position in which they will be in 1 seconds and projects it onto the road surface by laser beams. Lasers are expensive and continuous operation will demand good power supply, this might be impossible to implement in ordinary affordable cars and utility cars.

Likewise, [11] presented a system that combats congestion by removing the driver from controlling the vehicle's acceleration and braking thereby limit rear end collisions and enhance driver convenience. However, the system is restricted to be used only in a heavy traffic situation.

The approach in [12] uses sensors that send and receive signals from cars; obstacles in the road traffic lights and even a central database is placed within the car to tell whether traffic precaution to be taken. But the system has a high cost of implementation and is limited to electrical interference which could affect the proper functioning of the system.

In [8], the system avoids the possibility of collision where speed is below 20 km/h and also keeps the driver in alert mode, to prevent collision. The implemented system is without any counter measure to avoid collision.

Also, [13] employs the use of raspberry pi and ultrasonic sensors to detect and measure the distance with respect to moving or stationary objects. The sensors are imbedded to detect obstacle in front of the vehicle as well as obstacle present in the blind spot of the vehicle. The system is without any counter measure to avoid collision.

The work in [14] uses radar detector which sends out quick bursts of high-frequency radar waves. These waves will bounce off the nearest objects and return to the sensor, where it calculates the distance, speed and relative velocity almost immediately. The system is restricted to the use of visual warning only to alert the driver.

In [15], the approach employs elementary robotics, digital imaging, image processing and artificial intelligence to accomplish its operational activities, such as steering, speed control circuits and collision detection systems. The system is available only for gear-less two-wheelers only and the tracking

mechanism involves painting two white strips along the length of the road where it moves.

Also, [12] presented the approach that is implemented by Laser sensor, which identifies vehicles by using Laser rays, by transmitting and receiving. The Laser transmitter is connected to the laser sensor and a Controller Area Network (CAN) which connects to all sides of the node, and sends the information via Zigbee and transmit the message to the LCD output on the driver side. The system is restricted to transmitting and receiving without counter-action to avoid collision.

The system in [16] uses a network of sensors to monitor the environment of a vehicle, so as to measure the distances to other vehicles and check the possible obstacles. The key issues that have slowed the progress of this field include: Software complexity, Vehicle modeling system cost and Sensor integrity.

In [17] the system detects objects or obstacles using sonar sensors which produces the sound waves and receives the waves reflected back from the obstacle, including avoidance algorithms as Basic reflexive collision avoidance system. The systems limitation as shown in the implementation is the sensor integrity.

III. SYSTEM DESIGN

The following assumptions are made during the system design.

- A vehicle with 4 wheels is considered
- Braking torque is applied on all of the 4 wheels
- Vertical, roll and pitch motion are ignored
- The braking dynamics are considered as linear first-order system
- Effect of the suspension on the tire axels is discounted

The following parameters are also considered during the design of the vehicle model.

- Lateral velocity (speed) of the vehicle, v m/s
- Angular velocity of the wheels, ω rad/s
- Mass of the vehicle m kg
- Radius of the wheel, R m

Consider Fig. 1 showing the Cartesian representation of the vehicle, target or goal and obstacle model.

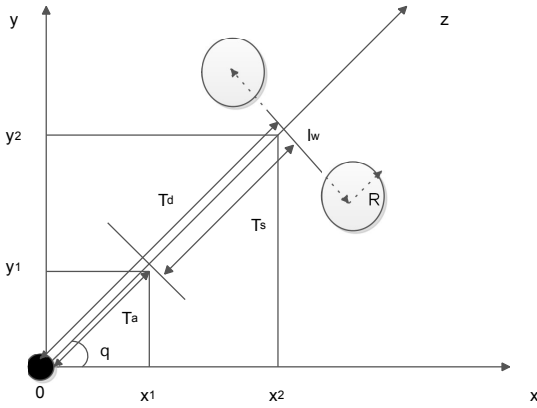

Fig. 1. Cartesian representation of the vehicle obstruction avoidance model

Vehicle dynamics are driven from Fig 1. The initial position of the vehicle can be represented by a position vector given as:

$$P_i(t) = \left[y_i \tan \theta \quad T_d^2 - y_i^2 \tan^2 \theta \quad \tan^{-1} \left(\frac{y_i \tan \theta}{y_i} \right) \right]^T \quad (1)$$

where x , y and θ are the vehicle horizontal displacement, vertical displacement and angular inclination respectively. The distance between the vehicle and the obstacle is given as: $T_d = T_s + T_a$, while, T_s and T_a are the target stoppage distance and the avoidance range respectively. The Braking force, $F_B(T_d, \omega, v)$ could be modelled as (2):

$$m \left[\frac{d^2}{dt^2} P_i(t) \right] - F p_{i(t)} = 0 \quad (2)$$

where

$$F p_{i(t)} = \begin{cases} -F_B(T_d, \omega, v) & (0 < \frac{d}{dt} P_i(t)) \\ 0 & \text{Otherwise} \end{cases} \quad (3)$$

and $F p_{i(t)}$ is the component of the torque at the initial position.

The following kinematic equations (Equations 4 and 5) describe the rate at which the vehicle position changes.

$$\frac{d}{dt} P_i(t) = \begin{bmatrix} \frac{dx}{dt} \\ \frac{dy}{dt} \\ \frac{d\theta}{dt} \end{bmatrix} = \begin{bmatrix} \cos \theta & 0 \\ \sin \theta & 0 \\ 0 & 1 \end{bmatrix} \begin{bmatrix} v \\ \omega \end{bmatrix} \quad (4)$$

where

$$\begin{bmatrix} v \\ \omega \end{bmatrix} = \begin{bmatrix} \frac{R}{2} & \frac{R}{2} \\ -\frac{R}{l_w} & \frac{R}{l_w} \end{bmatrix} \begin{bmatrix} \omega_l \\ \omega_r \end{bmatrix} \quad (5)$$

And R is the radius of the wheel, l_w is the distance between the two wheels, ω_l is the angular velocity due to left wheel and ω_r is the angular velocity due to the right wheel.

A. Implementation in Maplesim

The system is firstly implemented in Maplesim simulation environment. Fig. 2 shows the adopted simulation model in Maplesim.

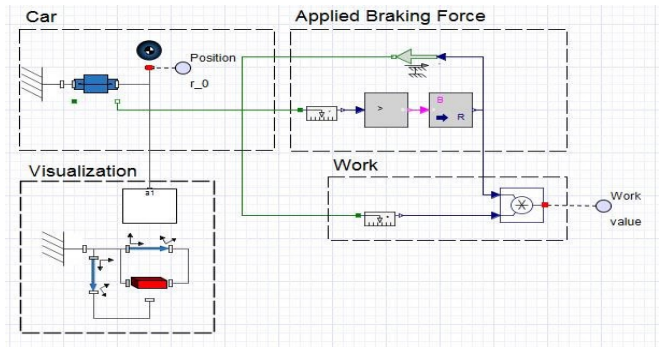

Fig. 2. Vehicle braking model

B. Prototype implementation

The system uses an ultrasonic module interfaced to the microcontroller board Arduino Uno. An ultrasonic transducer comprising of a transmitter and receiver is used for the project. Arduino Uno sends a trigger pulse to the Ultrasonic sensor which then transmits ultrasonic waves. The transmitted waves are reflected back from the object & received by the transducer again. Ultrasonic sensor sends echo pulse to the Arduino Uno. The Ultrasonic sensor converts the sound signal to electrical signal which is processed in microcontroller to measure distance. The total time taken from sending the waves to receiving it is calculated by taking into consideration the velocity of sound. Then the distance is calculated by a program running on the microcontroller. The measured distance can be used as a control parameter by the user to generate an audio-visual warning as well as to trigger automatic control outputs for deceleration and automatic brakes depending on the threshold parameters set according to the software program. The block diagram is shown in Fig. 3:

The general block diagram comprises of Power supply unit (a DC battery which can supply up to 12v and the circuit takes up 7-12V and supplies 5V DC to the microcontroller), sensors and other Output devices, range sensing unit (forward and reverse ultrasonic range sensors) for distance measurement, warning unit - consisting of Buzzer, LCD and LED displays to provide warning signals to driver of vehicle or road users and braking unit for braking purposes. The flow chart of the system is shown in Fig. 4.

Circuit pin connections of the various components are implemented using the Proteus software. Fig. 5 shows the circuit diagram.

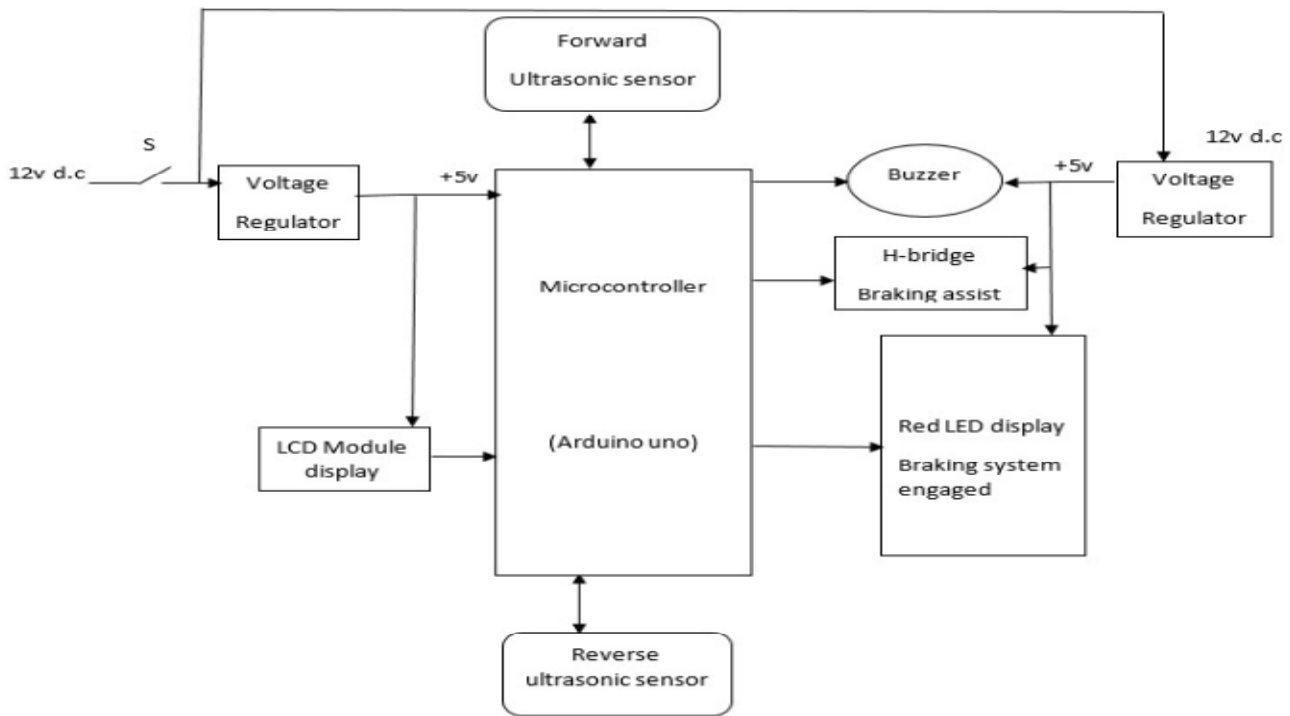

Fig. 3. System block diagram

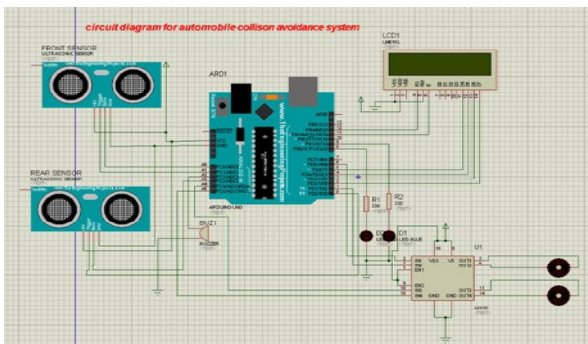

Fig. 5. Circuit Diagram of the Automatic Braking Collision Avoidance System

1) *The Power Supply Unit:* The power supply system designed in this research supplies the desired voltages to the micro-controller and the buzzer, LCD and LEDs. The system operates at a voltage of 5V DC. Therefore, from a voltage source of (7-12V) DC in this case, 12V battery will be used to power the prototype, a voltage regulator is used to give stable

5 volts DC, however, the regulated output usually vary between 4.8-5.2V.

2) *Range Detecting Unit:* The distance detection mechanism is made up of range ultrasonic sensors. The HC-SR04 ultrasonic sensor modules are used in this research. The range sensor uses sonar to determine distance. It is stated that SR04 ultrasonic sensor modules are used in this research. The range sensor uses sonar to determine distance. It is stated that HC-SR04 offers an excellent range accuracy and stable readings in an easy-to-use Package. Also, the operation of HC-SR04 is not affected by sunlight or black material like IR range sensors, the ultrasonic sensor can measure up to a maximum distance of 400cm and a minimum distance of 3cm.

Wire connection for the ultrasonic sensor modules is described as:

- VCC is connected to 5V Supply.
- Trig, which is Trigger Pulse Input is connected to microcontroller digital input/output pin.
- Echo which is Echo Pulse Output is connected to microcontroller digital input/output pin.
- GND is connected to 0V Ground.

3) *Warning Unit:* This subsystem provides reliable warning to drivers about a possible collision prior to their reaching an unsafe position or location. The composition of the warning system comprises of the buzzer, LED and LCD. The mode of operation of the warning system is, a red LED will light upon detecting an object, if the object is 3 meters away while being displayed on the LCD, the buzzer starts buzzing,

when the object is 2 meters close to the automobile the precautionary braking system to avoid collision is engaged.

4) *Design and Interfacing for LEDs:* LEDs are operated from a low voltage DC supply, with a series resistor to limit the forward current to a suitable value of about 5-6mA.

5) *Distance Calculation:* The time of Input Output duration is captured, which represents the time from sending ultrasonic vibrations to the time it takes for it to hit an object

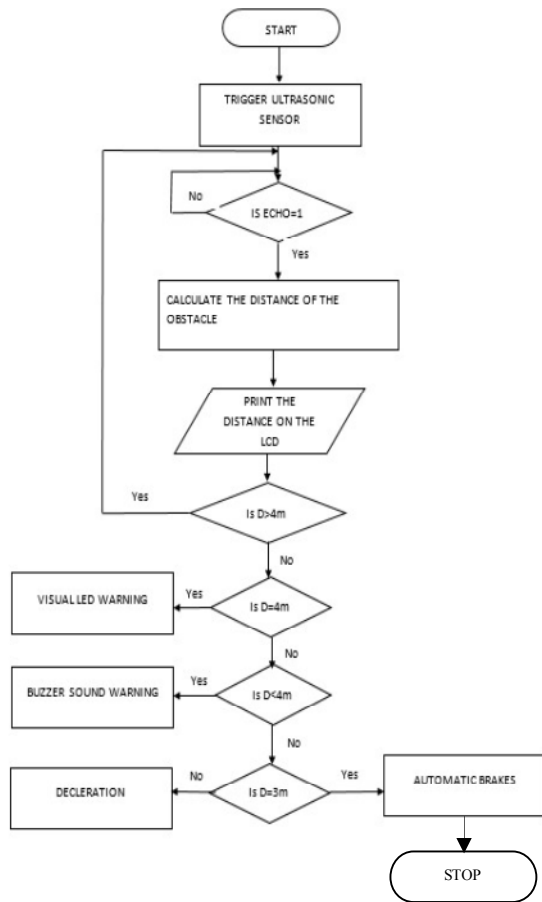

Fig. 4. System block diagram

and bounce back. Since sound travels at a velocity of 343m/s in air or 1130 feet per second.

$$Test\ distance = high\ level\ time \times \frac{velocity\ of\ sound}{2} \quad (6)$$

Division by two is because the high time includes sending time to object and receiving time for the echo. Temperature adjustments are calculated using (7).

$$v = 331.5 + 0.6 \times T_{air} \quad (7)$$

where v is the velocity of sound in air and T_{air} is the air temperature in degree Celsius. At 20°C, the velocity of sound in air is = $331.5 + 0.6 \times 20 = 343.5$ m/s

The Sound speed formula is given in (8).

$$(8) \quad 574$$

$$C = 331.3 \times \sqrt{\frac{9 + 273.15}{273.15}} = 336.71$$

6) *The Microcontroller selection:* In this work, Atmega 328p Arduino microcontroller was used. The choice of the controller is because of the following reasons- Easy to program with high level language programming using C, C++ and Java, it has relatively 13 digital and 5 analog pins, thus more inputs and outputs taken, has 6 PWM channels, hence direct output into hazard and braking subsystems, has relatively high memory capacity and inbuilt ADCs which makes it easy to interface with analog inputs band on board encoders.

7) *The Control unit:* The control subsystem consists of the Arduino circuitry controlled by a program loaded in its memory. The Arduino circuitry consists of an Atmega 328p microcontroller chip, a 16 MHz crystal oscillator, two 22 pF capacitors and a reset button. The 16 MHz crystal is used for timing; the reset button is used to reset the microcontroller to upload a new program or to start running the existing program from the beginning.

8) *H bridge:* Is an electronic circuit which enables voltage to be applied across a load in either direction, where h is often used in various applications to allow DC motors to run in forward and backward direction.

9) *Working Configuration:* The DRV883x family of devices provides an integrated motor driver solution for cameras, toys, and other low-voltage or battery-powered motion control applications. The device can drive one DC motor or other devices like solenoids. An internal charge pump generates needed gate drive voltages and can supply up to 1.8 A of output current to operate with the motor. The power supply voltage used is from 0 to 11 V. The device has a PWM (IN1-IN2) input interface and a PH-EN input interface both interfaces are compatible with industry-standard devices as shown in Table I. Internal shutdown functions are provided for overcurrent protection, short-circuit protection, under voltage lockout, and over temperature.

TABLE I. DRV8838 DEVICE LOGIC SHOWING THE OPERATIONAL LOGIC OF THE

nSLEEP	IN1	IN2	OUT1	OUT2	FUNCTION(DC motor)
0	X	X	Z	Z	Coast
1	0	0	Z	Z	Coast
1	0	1	L	H	Brake
1	1	0	H	L	Reverse
1	1	1	L	L	Forward

The pictorial views of the implemented prototype of the automobile automatic braking collision avoidance system as depicted in Fig. 6.



Fig. 6. Front and rear view of the prototype showing ultrasonic sensors

IV. TESTING AND RESULTS

A. Performance Evaluation

Various tests were carried out on the system even before it is completed, the connection between the various subsystem of the system were tested to ensure proper and firm connection between the components.

1) *Collision Distance*: The distance measured by the ultrasonic sensor were found to vary from the actual measurement taken, since the reliability of the system is very much dependent on the distance acquired from the sensors it was calibrated to give the expected readings. Distance results are shown in Table II.

TABLE II. TEST FOR COLLISION AVOIDANCE DISTANCE

Test	Expected distance (cm)	Actual distance (cm)
1	30	28
2	30	24
3	30	29
4	30	25
5	30	26
6	30	29
7	30	23
8	30	27
9	30	24
10	30	27

Percentage error is calculated using:

$$P.E = \frac{E_{av} - M_{av}}{M_{av}} \times 100 \quad (9)$$

where E_{av} and M_{av} are the average expected value and average measured value respectively. P. E is the Percentage Error. P.E yields 12.8%.

Fig. 7 shows the calibrated distance of the operation of the ultrasonic sensor and the actual distance of operation the sensor as derived from the several test carried out.

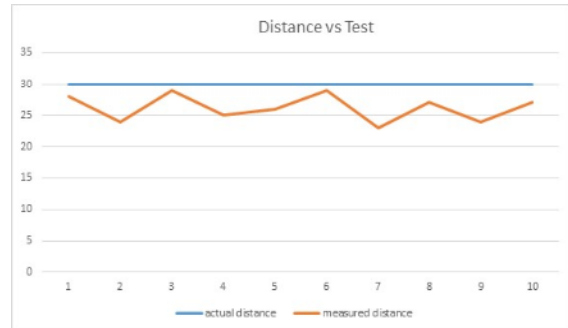

Fig. 7. Actual and measured distance of the sensor during operation

2) *System Response*: The readings obtained from the sensor during the testing were very good, after the calibration, Table III shows the system response, which is the time it takes to trigger the alarm and stop the car.

TABLE III. TEST FOR COLLISION AVOIDANCE DISTANCE

Test	Time Taken (seconds)
1	0.7
2	0.9
3	0.8
4	0.7
5	1.0
6	1.1
7	0.8
8	0.7
9	0.9
10	1.0

$$\text{Average response time} = \frac{\text{total response time}}{\text{total test}} \quad (10)$$

$$\text{Average response time} = (0.7 + 0.9 + 0.8 + 0.7 + 1.0 + 1.1 + 0.8 + 0.7 + 0.9 + 1.0) / 10$$

$$\text{Average Response Time} = 0.86 \text{ seconds.}$$

The system response time performance is depicted in Fig. 8.

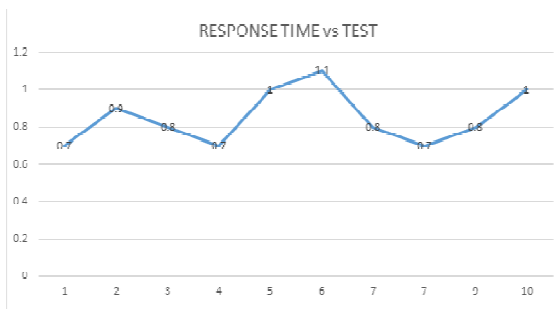

Fig. 8. graph showing the systems various test points and the response time

B. Discussion of Result

Results shown in Table II depicts the actual distance calibrated for the car to stop in order to avoid collision and the actual distance it stopped after the counter measure anti-collision signal was engaged, which was accomplished by setting a measured distance of 30cm which is the expected distance and the braking distance which is the actual distance it stopped and the measurements taken. Which shows that the performance of the system is above average and still operating at a safe distance without much difference in margin from the calibrated distance. The actual distance calibrated for the car to stop in order to avoid collision and the actual distance it stopped after the counter measure anti-collision signal was engaged, which was accomplished by setting a measured distance of 30cm which is the expected distance and the braking distance which is the actual distance it stopped and the measurements taken. Which shows that the performance of the system is above average and still operating at a safe distance without much difference in margin from the calibrated distance.

V. CONCLUSIONS

The development of an automobile collision avoidance, by implementing an ultrasonic sensor based collision avoidance system is presented. The objective was to reduce collisions so as to reduce death of persons, death of wildlife, automobile damages and damages to property upon collision and thus eliminate the related costs. For the system to perform this desired functions, it was implemented as an automatic system, based on Atmeg 328 microcontroller. The implemented system was able to determine the separation distances between automobile and obstacle appropriately, gives warning by means of on board warning systems, and engage braking at a minimum separation distance that is provided with an average response time of 0.86s and a percentage error of 12.8% during operation. The objectives were met as desired. The following directions will be considered in the future:

- The system could be implemented on an automobile as opposed to a prototype.
- The incorporation of fuel injection control can be used which in combination with braking control will be able to provide more precise automobile speed control.

- A possible combination of ultrasonic sensors and radar based sensors will provide an improved safety system that can be implemented in cars.

ACKNOWLEDGMENT

We would like to acknowledge the Department of Computer Engineering, Federal University of Technology of Minna for providing us with the required laboratory space and fund towards actualizing the work presented in this paper.

REFERENCES

- [1] V. N. Ukoi, "Trends and patterns of fatal road accidents in Nigeria (2006–2014)". *Internet: http://www.ifra-nigeria.org/IMG/pdf/fatalroad-accidents-nigeria.Pdf* Nov, 2014.
- [2] S. Srivastava, R. K. Kanaujia, and S. K. Singh, "Collision avoidance system for vehicle safety," vol. 3, 2015.
- [3] WHO, "Global status report on road safety, Switzerland: World Health Organization." 2015.
- [4] I. Gonzalez, F. Catedra, M. Algar, A. Gonzalez, A. Somolinos, G. Romero and J. Moreno, "Analysis of Collision Avoidance Systems for Automobile Applications," *Antennas and Propagation (APSURSI), 2016 IEEE International Symposium on.* IEEE, 2016. pp. 633–634.
- [5] M. Mahdi, E. Frisk and J. Åslund. "Real-time velocity planning for heavy duty truck with obstacle avoidanc,." *IEEE Intelligent Vehicle Symposium.* 2017.
- [6] L. Tsung-Hsin, M. Hsu and Z. Tsai. "Mutual interference of pseudorandom noise radar in automotive collision avoidance application at 24 GHz," *Consumer Electronics, 2016 IEEE 5th Global Conference,* 2016.
- [7] S. Shanmathi and C. kamanalathan, "Arduino based vehicle collision detection using CAN protocol," *International Journal of Research and Development Organization,* vol. 2, April, 2015.
- [8] B. Varghese, J. R. Thomas, F. Kamar, and S. R. Ali, "Collision avoidance system in heavy traffic and blind spot assist using ultrasonic sensor," *International Journal of Computer Science and Engineering Communications,* vol. 2, 2014, pp. 93–96.
- [9] T. Nishi, N. Yamazaki, S. Kokie, T. Kuno, and T. Umzaki, "Collision avoidance system using laser beams," 2009.
- [10] M. Nyemi, "Vehicle safe drive system. kakamega," 2012.
- [11] P. Bjornert, G. Allegretto, M. Allegretto, and J. Small, "Autonomous cruise control system," 2014.
- [12] R. Shanmathi, "Vehicle collision avoidance system using wireless sensor networks," *International of Soft Computing and Engineering,* vol. 2, 2012 pp. 2231–2307.
- [13] S. Garethiya, L. Ujjainiya, and V. Dudhwadkar, "Predictive vehicle collision avoidance system using raspberry – pi," *ARNP Journal of Engineering and Applied Sciences,* vol. 10, May, 2015, pp. 3655–3659.
- [14] M. Momani, "Collision Avoiding System (CAS)," in *Contemporary Engineering Sciences,* vol. 5, 2012, pp. 541–354.
- [15] M. Pagarkar, "Automatic vehicle control system," 2014.
- [16] G. Der-Khachadourian, "Autonomous navigation and collision avoidance of a scale model robot using smartphone sensors," 2013.
- [17] A. Lang, D. Jonnagadla, A. Hammond, and A. Atahua, "Model based systems engineering design of an automobile collision avoidance system," 2011.